



Moving Health Forward

EN User Manual

# VENDLET

## V5S

## V5S Speed Adjust

## Bari





Congratulations on your new VENDLET. The VENDLET is used for handling bedridden clients, for example:

- Turning to lateral, prone or supine positions
- Moving from one side of the bed to the other
- Repositioning the client up in the bed
- Transferring the client from one bed to another

This manual covers the following 3 VENDLET models:

<b>VENDLET V5S</b>	Max . user weight 200 kg	1 speed
<b>VENDLET V5S Speed Adjust</b>	Max . user weight 200 kg	3 speeds
<b>VENDLET Bari</b>	Max . user weight 400 kg	3 speeds

Whenever this manual refers to VENDLET, it applies to all 3 models. If the situation only applies to one or more of the models, it will refer specifically to each model.

The instructions in this manual must be followed. Vendlet ApS shall not be liable should the VENDLET be used, modified, or assembled in a way that is not described in this manual.

This manual is divided into three parts:

- Part 1 contains general information that is useful to everyone responsible for the purchasing, examination, use, assembly, and maintenance of the VENDLET.
- Part 2 is a user manual containing information about the operation and daily maintenance of the VENDLET.
- Part 3 is a technical manual containing information about the assembly, maintenance, and service of the VENDLET.

## Contents

### Part One: General Information

Intended Use .....	04
Product Description .....	04
Bed & Mattress Compatibility .....	06
Warranty & Service Life .....	07
In the Event of an Incident .....	07
Symbols .....	08

### Part Two: User Manual

Operation .....	09
Attaching the Sheets .....	14
Evacuation .....	16
Daily Maintenance & Troubleshooting .....	16

### Part Three: Technical Manual

Unpacking .....	18
Parts List .....	18
Mounting .....	18
Quick Guide Location .....	26
Additional Accessories .....	26

Final Inspection List .....	27
Dismounting, Storage & Remounting .....	28
Maintenance/Check .....	28
Troubleshooting - Technicians .....	29
Repairs .....	30
Spare Parts .....	32
Technical Data .....	32
Environmental Conditions & Disposal .....	32

## PART ONE: GENERAL INFORMATION

### Intended Use

The VENDLET may be used for moving clients to a lateral, prone, or supine position, from one side of the bed to the other, or, to reposition them further up in bed. The VENDLET may also be used in connection with mobilisation in and out of bed and when transferring clients from one bed to another.

The VENDLET protects the caregiver from physical strain and heavy lifting in connection with the handling of immobile clients. Clients are turned/handled by pressing a hand control whereby the caregiver may support a client and ensure their correct and comfortable positioning. This provides room for increased awareness in the care, which boosts employee job satisfaction and client well-being.

To the client, the turning process becomes uniform and steady as the sheet supports the body over its full length.

The target group is clients who are being cared for, dressed, washed etc. in bed. This will often be clients who are lifted in and out of bed or clients who are mobilised using a standing aid. Hence, the user will typically be clients with few physical and/or cognitive resources and palliative clients.

The VENDLET is also suitable for clients at risk of developing pressure ulcers in that the uniform and steady transfer in the sheet minimises friction and the associated shear that can damage the tissue and cause pressure ulcers. Furthermore, the

VENDLETs often seem to have a positive effect on clients suffering from spatial awareness.

The VENDLET is intended for clients weighing at least 30 kg.



For clients weighing less than 50kg take extra care not to lift the client from the bed when the system is in operation.

VENDLET V5S / VENDLET V5S Speed Adjust has a load capacity of max. 200 kg.

VENDLET Bari has a load capacity of 400 kg. The target group this model is bedridden bariatric clients.

Prior to the first use of the VENDLET, it is important to assess whether the VENDLET is suitable for the client in question. It may be necessary to take special precautions, for example if a client is very restless in bed or has an untypical anatomy.

For safety reasons, it is recommended that the VENDLET is not operated by the bedridden person.

### Contraindications

Do not use the VENDLET for clients with unstable fractures, gross oedema, burns or equilibrium disorders.

Prior to the first use of VENDLET, it is important to assess whether VENDLET is suitable for the client in question. It may be necessary to take special precautions, for example if a client is very restless in bed or has an untypical anatomy.

### Product Description

The VENDLET system consists of two bars fitted with motors. The bed is fitted with a motorised bar on both sides; the bar on the left side of the client has a blue colour marking and the bar on the right side of the client has a red colour marking. Each motorised bar is fitted with a long velcro strip which makes it possible to attach a long turning sheet between the two bars. The turning sheet is wrapped around the two bars, making it possible to move it from side to side.

A slide sheet is inserted under the turning sheet in order to reduce the friction of the turning sheet against the mattress.

The bars are fitted with an actuator at each end in order to raise and lower the bars.

To allow the individual adjustment of the VENDLET to any bed and mattress, the actuators are mounted on height-adjustable brackets.

Furthermore, the VENDLET consists of a control unit and a hand control. The control unit is placed underneath the bed.

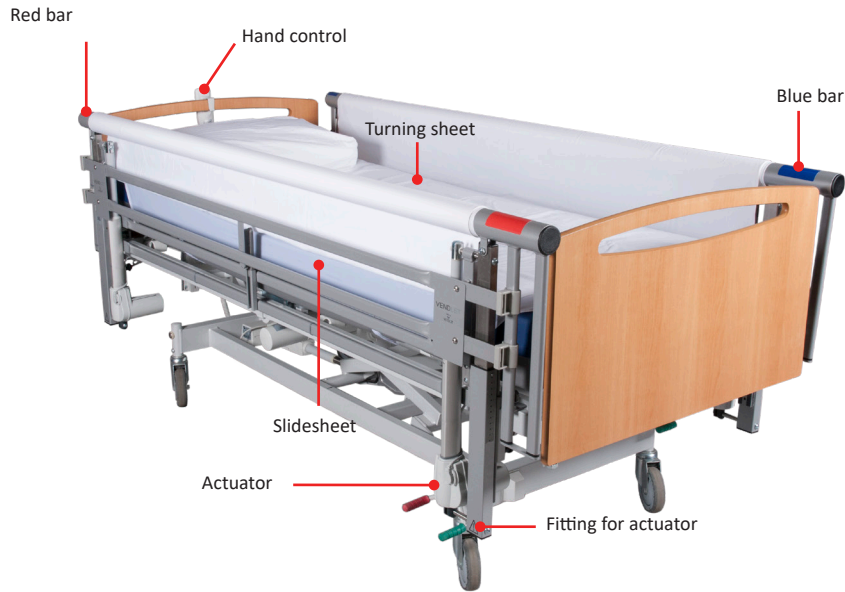

When the bars are raised VENDLET can be used as side rails. Note! This applies only to the VENDLET models that this manual covers.

**How VENDLET Works**

The VENDLET is switched on by double-clicking the  on the hand control. The VENDLET produces a “beep” upon activation and the green diode over the power symbol turns on.

When a VENDLET has been inactive for 90 seconds, the system produces a “beep-beep” sound, the diode turns off, and then the VENDLET system is off again.

When the VENDLET has been turned on, the bars can be turned

in both directions or raised or lowered. The colour coding on the bars relates to the colours on the hand control buttons.







With VENDLET V5S Speed Adjust and VENDLET Bari the speed of the bars can be reduced, so the speed is running at 75% or 50% of normal.

Press and hold the individual buttons long enough to obtain the desired operation; the motors will stop when the button is released. Likewise, you may stop an activated function by clicking the .

When the bar is up on the side where the turning sheet is being tightened, the client will be turned. If, on the other hand, the bar



Hand control for: VENDLET V5S

- |  |   |   |   |   |
|--|---|---|---|---|
| Tighten the sheet on the red bar         | → |  | ← | Tighten the sheet on the blue bar         |
| Slacken the sheet on the red bar         | → |  | ← | Slacken the sheet on the blue bar         |
| Raise the red bar                        | → |  | ← | Raise the blue bar                        |
| Lower the red bar                        | → |  | ← | Lower the blue bar                        |
| Speed Adjustment                         | → |  | ← | Flash light / Under bed light (accessory) |
| Power w. illuminated diode / stop button | → |  | ← |   |



Hand control for: VENDLET V5S Speed Adjust VENDLET Bari

is down on the side where the turning sheet is being tightened, the client will be moved towards the edge of the bed. These fundamental principles provide you with a number of ways to move and/or transfer clients. See the “How to Use the VENDLET” section in Part 2 – User Manual for further details.

The VENDLET can be operated by only one person (caregiver or relatives etc).

### Warnings



As it is recommended that the clients does not operate the VENDLET themselves, the hand control must be placed on the outside of the bed before leaving the client.



Lowering the bed to a very low position may leave the actuator bracket very close to the floor. Consequently, you should not place your feet under the actuator fittings.



The bed's lowest height can be restricted on certain types of beds by mounting height restriction brackets.



If the client has long and loose hanging hair, the hair could in some situations be rolled onto the bar, when the sheet is tightened. Therefore, long loose hair should always be collected before moving and handling the client.



The client must not hold on to the edge of the turning sheet or bar during the transfer. If the client is restless and needs something to hold on to, we recommend they get a handle such as a FlexiGrip

### Accessories

#### **Height extensions, spacers, side rail extensions and brackets:**

If particularly thick mattresses are used, it may be necessary to use height extensions, see page 23. Further, it may be necessary to use spacers if the distance between the VENDLET system and the mattress is insufficient, see page 22. Spacers and height extensions are available as accessories.

The system is standard 200 cm long. When using extra-long beds, it can be necessary to extend the length of the VENDLET system, see page 23.

Brackets that makes installation on different types of beds easier

are available, see page 26.

#### **Additional hand control:**

An additional hand control can be connected if a hand control is required on both sides of the bed, see page 24.

#### **Wider sheets:**

Wider turning sheets and slide sheets are also available if the VENDLET is to be used on wider beds, see page 14.

#### **Battery backup and under bed light:**

Additionally, a battery backup is available to operate the VENDLET without a connection to the supply network. We also provide an under bed light that may be activated via the VENDLET hand control, see page 26.

### Bed & Mattress Compatibility

The VENDLET is intended for mounting on a wide range of hospital and care beds and with a wide range of mattresses. The following bed and mattress requirements must be met.

#### **Bed requirements**

The bed must meet the EN 60601-2-52 standard or the expired EN 1970 or EN 60601-2-38 standards.

The bed must have a square steel frame (dimensions H 45-50 mm, W min. 20 mm, L min. 195 cm. without protrusions). The bed width is not crucial as extra wide turning sheets and slide sheets are available.

VENDLET can be mounted on most beds with these dimensions. But situations where VENDLET cannot be mounted can occur.



The maximum user weight and safe working load of the bed must not be exceeded following the installation of VENDLET.

#### **Mattress Requirements**



The mattress must meet the requirements of the bed manufacturers and be suitable for the bed.

The maximum user weight specification of the mattress must not be exceeded.



Following the mounting of the VENDLET, the distance between the mattress sides and side rails must be minimum 2.5 cm and maximum 4 cm, see page 19.



If the mattress is soft and easily compressible, it must be ensured that there is no entrapment hazard due to extra compression at the edge of the mattress.

When alternating air mattresses are used, it should be possible to inflate the mattress to a firm state before VENDLET is operated. Soft mattresses will increase the friction against the mattress and create an uneven base which will be uncomfortable for the client when VENDLET is operated.



If the client changes mattress, the VENDLET installation must be evaluated. A new mattress might change the conditions and necessitate the reinstallation of VENDLET to reduce the risk of entrapment.

## Warranty & Service Life

DHG provides a 1-year factory warranty on all electric parts. Opening the control unit, actuators, or hand control will void the warranty.



Certain types of care and hospital beds have a particularly long bed frame, which means that the actuator may collide with the bed brake, when the bed is lowered. Further, the mattress frame may in some cases collide with the actuator, if head end or foot end is lowered considerably.

Damage to the actuator, due to collision with bed parts, are not covered by the warranty.

To prevent the above problem by limiting the bed's lowest height, or by turning the actuator, read more on pages 26.

DHG provides a 3-year warranty on all mechanical parts (except sheets).





















The normal VENDLET service life is 10 years. The service life may be significantly extended if the product is used and handled with care and maintained in accordance with the guidelines in this manual.

## In the Event of an Incident

In case of an adverse event or a near-accident involving the VENDLET system, the accident must be reported to the competent authority in the country in which the accident happened.

Likewise, we kindly request that you also inform DHG on tel. +44 (0) 800 043 0881 or [info@directhealthcaregroup.com](mailto:info@directhealthcaregroup.com)

## Symbols

	CE marking: The product complies with the Medical Device Regulation (EU) 2017/745
	This product is a medical device
	Legal manufacturer
	Date of manufacture
	Serial number
	Item no. / Catalogue number: 7 digits
	Unique Device Identification
	Consulting the manual is mandatory
	Warning triangle indicates when special attention is necessary
	For indoor use
	This product is a class II equipment (IEC 61140)
	The product is a type B equipment according to EN 60601-1
	Max. user weight
	Electronic scrap. When disposing of the products, sub-components should be recycled
	Product must be operated between 5 and 40°C.
	Product must be stored between 0 and 50°C.
	Product must be stored between 20 and 90% humidity at 30°C.
	Keep dry (during storage)
Rev.	Revision no of the label. Printed vertically.
	Power / stop button
	Speed Adjustment
	Tighten the sheet on the red or blue bar
	Slacken the sheet on the red or blue bar
	Raise the red or blue bar
	Lower the red or blue bar
	Light on Speed Adjust hand control or under bed light on hand control without speed adjust



## PART TWO: USER MANUAL

### Operation

Handling clients with a VENDLET system enables caregivers to work on a one-to-one basis: one hand is used to operate the hand control and the other hand is free to guide the arms and legs of the client. In order to improve the safety and well-being of the client, we recommend that you place the hand holding the hand control on the shoulder of the client or similar.

You should always use the resources of the client. For example, if the client can move his/her arm to the side, he or she should do so.



Always, keep focus on the client when using VENDLET.







Remember to leave the hand control on the outside of the bed before leaving the client.

### How to use VENDLET

#### Turning

The VENDLET may be used to turn clients. Follow this procedure to move a client from a supine position to lying on his/her right side:

1. Double-click the  button to activate the VENDLET.
2. Press the  button to raise the blue bar.
3. If necessary, press once or twice on  to reduce speed (Speed Adjust).
4. Press the  button to tighten the turning sheet on the blue bar.
5. Place the left arm of the client on his/her stomach or chest the moment before he/she starts turning.
6. Immediately after this, guide the right arm of the client to the side.
7. Then shift the left leg in parallel above the right leg.
8. The client now lies on his/her right side.

The red bar does not necessarily have to be raised. But if this makes the client or the caregiver feel more safe, the red bar could be raised during the process.

Moving clients with the VENDLET is ideally suited for dressing and access to care tasks and hygiene, applying a sling, and repositioning.



Guide the right arm of the client to the side







Shift the left leg of the client in parallel above the right leg

Watch instruction videos on our webpage [vendlet.com](http://vendlet.com) or scan the QR-code.



#### Moving from one side of the bed to the other

The VENDLET may also be used to move clients to the side of the bed.

1. Double-click the  button to activate the VENDLET.
2. Press the  and  buttons to lower the bars if they have been raised.
3. If necessary, press once or twice on  to reduce speed (Speed Adjust).
4. Use the bar on the side to which the client should be moved and tighten the turning sheet.

In many situations, this will give the caregiver a better work posture, for example in connection with examinations, training, care tasks, dressing, etc.











Sound work posture in connection with examination

### Repositioning the client up in the bed

It is a well-known problem that clients often slide down to the foot end, for example when the back support has been raised – even if the kneebreak on the bed was activated before the back support.

Typically, when a client slides towards the foot end, the turning sheet follows the body of the client. In such situations, you may use the VENDLET to move the client up in the bed again.

1. Double-click the  button to activate the VENDLET.
2. Press the  and  buttons to lower the bars if they are raised.
3. If necessary, press once or twice on  to reduce speed (Speed Adjust).
4. Press the  and  buttons to slacken the turning sheet.
5. Stand next to the headboard and press the  or  button to pull the client from side to side while you gently guide the turning sheet towards the upper end of the bar.
6. Repeat the procedure on the opposite side and so on until the sheet has been completely repositioned and the client is moved up in the bed again.



Gently guide the slack turning sheet towards the upper end of the bar



The turning sheet is now almost back in place

Watch instruction videos on our webpage [vendlet.com](http://vendlet.com) or scan the QR-code.



### Applying a sling

It is easy to apply a sling on the client when VENDLET is used.

1. Double-click the  button to activate VENDLET.
2. Use the turning function of the VENDLET system to move the client onto his/her side.
3. Place the sling along the back of the client and make sure that the sling is centred and correctly placed

in accordance with the instructions of the sling manufacturer.

4. Use the VENDLET turning function to move the client onto his/her back again.
5. Free the straps on the opposite side.
6. Place all straps in such a way that they are ready to be placed on the lifting beam of the hoist.

Watch instruction videos on our webpage [vendlet.com](http://vendlet.com) or scan the QR-code.



All straps are in place, and the client is ready for transferring







Place the sling along the back of the client



Pull the straps out on the opposite side

### Prone position

The VENDLET can also be used to turn a client to a prone position.

1. Double-click the  button to activate VENDLET.
2. Place the clients right arm closely along his body with the palm of the hand facing the thigh. Move the pillow and, if necessary, place it close to the right upper arm so that the client comes to lie with his chest on top of the pillow.
3. Press the  button to raise the blue bar.
4. If necessary, press once or twice on  to reduce speed (Speed Adjust).
5. Press the  button to wind the turning sheet onto the blue bar. The VENDLET system now turns the client. Hold your hands on the client's shoulder and hip to provide a sense of safety during the procedure.
6. Gently support the client as he/she is being turned to prone position.
7. Check that the clients head is comfortable and that there is room for breathing.



Watch a video on how to prone a client on our webpage [www.vendlet.com](http://www.vendlet.com) or scan the QR-code.



Place the client's right arm closely along his body









Gently support the client as he is being turned to prone position.



Check that the client's head is comfortable and that there is room for breathing.





### Transferring from one bed to another

When the client lies on a VENDLET, the VENDLET - in combination with a slide board and a slide sheet - may be used to transferring the client onto another bed.

1. First use VENDLET's turning function to place the sliding board underneath the client. Insert the sliding board from the side that is turned towards the new bed.
2. Press the  or  button to lower the bar facing the other bed.
3. Press the  or  button to raise the opposite bar.
4. Place a slide sheet on the other bed.
5. Place the other bed right next to the bed with the VENDLET and lower or raise the bed to a slightly lower position relative to the bed with the VENDLET.
6. Remember to lock the wheels on both beds.
7. Press the  or  button to pull in the turning sheet on the bar facing the other bed. Now, the VENDLET transfers the client and the slide board to the other bed and the slide sheet.
8. Hold the slide board with your hands and pull to move the client to the centre of the bed.
9. Remove the slide board and the slide sheet.

### Side rail

If it is assessed that the bedridden must use side rails, the VENDLET models described in this manual all have integrated side rails.

1. Press the  and  button to raise the bar to the highest position.
2. Press the  and  button to slacken the sheet before the client is left unattended in the bed.

Note: All previous VENDLET models require the use of plastic protectors.



VENDLET V5S, VENDLET V5S Speed Adjust, VENDLET Bari has an integrated side rail

### Using VENDLET in combination with bed functionality

None of the VENDLET models interfere with the functionality of the bed. Slacken the turning sheet before raising the back, thigh, and/or foot part of the bed.

Under normal circumstances, the bed surface must be level before you use the VENDLET.

In some situations, however, it may be advantageous to use the back or foot part of the bed when moving or turning clients. For example, if the client has wide hips and frail shoulders, he/she will rest more comfortably on the bed if the head and foot parts are raised a little before the process.

### Stop button

The power button  also functions as a stop button.

If the hand control button controlling the tightening of the sheet fails, the operation can be stopped by pressing the  button

### Pressure-relieving mattresses

The VENDLET systems do not reduce the effect of either pressure-relieving mattresses or alternating air mattresses. Pressure measurements have been performed which unambiguously show that the VENDLET systems do not have a negative impact on the pressure-relieving properties of the mattresses.

To prevent interference with the function of alternating air mattresses, the turning sheet must be sufficiently slackened before a client is left unattended in the bed.

At the same time, the velcro band on the slide sheet must not be fastened too tightly around the steel frame under the mattress, see also the section on mounting the slide sheet, page 14.

We recommend that alternating air mattresses are firmly inflated before patient handling as this brings higher comfort to the client during the process.

### Incontinence

VENDLET can also be used for clients using incontinence sheets. The incontinence sheet should have a minimum width of 125 cm so that it can follow the client's movements during turning. You should not use two small incontinence sheets as the client in this case will lie on a double edge, which increases the risk of developing pressure ulcers.

The incontinence sheet must not be wrapped around the bars, but instead must hang loosely out over the bars.

### Urine bag and drainage tube

If the client has a catheter or a drainage tube, it may be necessary to adjust the tubes, etc. individually.

Placing the urine bag or drainage tube at the foot end will often be an optimal solution. Should this not be possible, however, you could use long tubes with a view to hanging the urine bag or drainage bag on the outer surface of the VENDLET system. In such cases, the bag should be placed on the bed frame by the footboard and the tube routed between the footboard and the VENDLET bracket. Be careful to avoid squeezing the tube.

## Attaching the sheets

Place a slide sheet directly on top of the mattress, followed by the turning sheet which is then attached to the two bars. Slide sheets and turning sheets are available in standard bed sizes and with increased width which makes the VENDLET systems suitable for wider beds as well.

Slide sheet width	Fits mattress widths	Fits mattress length
95 cm (regular size)	80 - 90 cm	200 - 210 cm
95 cm - long	80 - 90 cm	210 - 220 cm
115 cm	95 - 110 cm	200 - 210 cm
115 cm - long	95 - 110 cm	210 - 220 cm
135 cm	110 - 130 cm	200 - 210 cm

Turning sheet width	Fits mattress widths
350 cm (regular size)	80 - 110 cm
400 cm	110 - 130 cm

### Slide sheet

1. Fold the slide sheet corner elastic straps around the mattress.
2. Check that the surface is smooth and even without creases and folds. Make sure that slippery side is facing upwards.
3. Fasten the velcro tapes around the mattress frame.  It is important that the tapes are fastened around the frame under the mattress and not around the bed frame as this will prevent the back, thigh, and foot parts of the bed from being raised. The tapes are long enough for thick mattresses.



The slide sheet is subject to extensive wear and must be checked regularly. The friction of the turning sheet against the mattress will increase if the bed is not fitted with a slide sheet or the slide sheet has been damaged. That will reduce the comfort of the client during moving and handling.

When an alternating air mattress is fitted with a slide sheet, it is important that the velcro tapes are not fastened around the frame under the mattress too tightly as this could interfere with the function of the alternating air mattress. Consequently, the





mattress should be fully inflated during fitting.

### Turning sheet

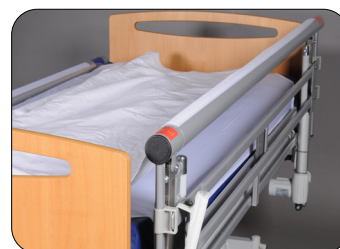
#### Attaching the turning sheet before use

1. Place the turning sheet in the middle of the bed, velcro tape facing downward.
2. Press the turning sheet onto the velcro strip on one of the bars; begin at the head of the bed and work your way down to the foot end.



3. The turning sheet must always be placed OVER the bars to prevent the fingers, hair etc. of the client from getting caught under the sheet. The pulling power will be reduced and the motors will switch off when the turning sheet is pulled in by the bar if the sheet is placed under the bars.
4. Press the  or  button on the hand control and allow approx. two-thirds of the sheet to be pulled in by the bar.
5. Press the turning sheet onto the velcro strip on the opposite bar.
6. Use this bar to pull in the turning sheet by pressing the  or  button until the sheet covers the mattress evenly with the red line at the centre of the mattress.





#### What should I do if the turning sheet is rolled askew on the bars?

Occasionally, the turning sheet will roll askew on the bars. As such, this is insignificant and the VENDLET system will still be operable.

This could result in creases in the turning sheet under the client which is undesirable. Hence, we recommend that you aim to smooth the turning sheet if the sheet is askew on the bars by more than a hand's width.

In this situation, you will have to slacken the sheet that has been pulled askew and pull it in again while guiding / smoothing it with your hand.

**Changing the turning sheet on an occupied bed**

1. Position the client on his/her side and then move him/her to the centre of the bed.
2. Remove the old turning sheet from the bar facing the back of the client and fold the sheet in layers with a width of approx. 15 cm. Place it behind the back of the client.
3. Attach the new turning sheet to the bar and press  or  button to roll the new turning sheet onto the bar. Allow approx. half of the new turning sheet to roll onto the bar and stop when the red line on the sheet is at the centre of the mattress. Fold the remaining part of the new turning sheet in layers of 15 cm and place it under the turning sheet being replaced.
4. Move the client to a supine position on top of the folded new and old turning sheets, and then on to the opposite side by activating the bar with the old turning sheet.
5. Remove the old turning sheet and attach the replacement sheet to the bar.

Watch instruction videos on our webpage [vendlet.com](http://vendlet.com) or scan the QR-code.



Place the new turning sheet under the turning sheet being replaced



Remove the old turning sheet



Fold the old turning sheet behind the back of the client



Attach the new turning sheet to the opposite bar

## Evacuation

Evacuation of persons from a bed with the VENDLET mounted should happen as standard procedure via the end of the bed. If this is not possible, evacuation can take place via the side of the bed.

### Evacuation via the foot end of the bed

1. Remove the footboard.
2. Cut the turning sheet between the mattress and the bar.
3. Evacuate the client via the end of the bed.

### Evacuation via the side of the bed

Evacuation from the side of the bed can take place in two different ways depending on whether or not the system is powered.

In case you have power:

4. Lower the bar on the evacuation side.
5. Use the VENDLET to drag the client out over the side for evacuation.

In case you do not have power:

1. Lower the bar in the evacuation side by loosening the position bolts as described on page 22
2. Cut the turning sheet between the mattress and the bar.
3. Pull the turn sheet with the bedridden person on to the side of the bed for evacuation.

## Daily Maintenance

The VENDLET system is a reusable piece of medical equipment intended for long-term use, requiring safe procedures in connection with cleaning and maintenance as well.

### Daily inspections

The VENDLET system must be checked daily in accordance with the checklist below. If a "Yes" checkbox is marked, this indicates a desired result. If a "No" checkbox is marked, this indicates a risk in which case the VENDLET system must not be used.

In case of malfunctions, faults, missing parts, or improper fitting, contact a person with relevant training for inspection or repair.

Checklist for daily inspections		In case of No, do not use VENDLET
1	Is the VENDLET free from visible damage and crooked brackets and fittings?	<input type="checkbox"/> Yes <input type="checkbox"/> No
2	Is the turning sheet in good condition and does the sheet run over the bars?	<input type="checkbox"/> Yes <input type="checkbox"/> No
3	Is the slide sheet fastened around the frame under the mattress and in good condition?	<input type="checkbox"/> Yes <input type="checkbox"/> No
4	Double-click the  on the hand control. Does the green diode on the hand control illuminate? Does everything work when you press the matching hand control buttons?	<input type="checkbox"/> Yes <input type="checkbox"/> No
5	Has it been verified that the condition of the client and the mattress/bed/client combination have not changed relative to when the VENDLET was mounted?	<input type="checkbox"/> Yes <input type="checkbox"/> No
6	Are the caregivers familiar with the instructions of this manual and have they received training in the use of the VENDLET?	<input type="checkbox"/> Yes <input type="checkbox"/> No
7	Is the quick guide located at an easily accessible spot near the bed?	<input type="checkbox"/> Yes <input type="checkbox"/> No
8	Has it been verified that the date of the next annual inspection has not come and gone?	<input type="checkbox"/> Yes <input type="checkbox"/> No



## Cleaning and washing instructions

### Cleaning of electrical and mechanical parts

Clean the electrical and mechanical parts with a damp cloth with water or a mild soap solution and then wipe the parts with a dry cloth.

### Washing instructions, slide sheet



Recommended washing temperature: 60°C  
Do not add fabric conditioner.



Do not tumble-dry



Do not iron

### Washing instructions, turning sheet



Recommended washing temperature: 90°C  
Max. 4% shrinking





Tumble-dry at normal temperatures



Iron or mangle at high temperatures

## Troubleshooting

Problem	Checklist
VENDLET does not run	Is the control unit connected to 230V outlet and is the power on? Is the green diode on the control unit illuminated?
	Are all plugs properly connected on the control unit?
	Is the green diode on the hand control illuminated? Double-click the  button to activate the system.
One of the bars does not turn	Are all plugs properly connected on the control unit?
One or both bars do(es) not turn when the client is lying on the turning sheet	Is the turning sheet running under the bars? The sheet must be over the bars.
	Are all plugs properly connected on the control unit?
One of the bars will only turn in one direction	Are all plugs properly connected on the control unit?
The symbols on the hand control do not match when the VENDLET is activated	Are all plugs properly connected on the control unit?
The actuators cannot be raised/lowered or do not go together	Are all plugs properly connected on the control unit?

1. If nothing else helps, try resetting the system by simultaneously pressing and holding the  and  buttons until you hear 10 beeps. Try using the system again.
2. Contact a person with relevant training or your distributor if the above does not solve the problem.

## PART THREE: TECHNICAL MANUAL

### Unpacking

The VENDLET is delivered in 3 boxes. Two of the boxes have a weight of 24 kg. The third has a weight of 18 kg.

The VENDLET systems are partially assembled on delivery, ready for mounting on the bed. Remove any loose packaging from the boxes. Check the packaging and contents for signs of damage and contact the distributor in case of obvious damage.

Store the VENDLET system in the original packaging until mounting. Always store the VENDLET system in a dry place, cf. the “Environmental Considerations” section.

#### Parts List

4	unit	Linear actuators
1	unit	Blue side complete
1	unit	Red side complete
1	unit	Suspension plate for the control unit
1	unit	Control unit with transformer
1	unit	Power cable - 230 V
1	unit	Hand control
1	unit	Slide sheet (or 10 disposable slide sheets)
1	unit	Turning sheet (or 10 disposable turning sheets)
1	unit	Quick guide
1	unit	Manual
1	unit	Slide sheet
1	unit	Turning sheet
1	unit	Quick guide
1	unit	Manual

### Mounting

The VENDLET system should always be installed by a person with relevant training. The VENDLET systems are only intended for mounting on care and hospital beds complying with the EN60601-2-52 standard or the expired EN1970 or EN60601-2-38 standards.

The bed must be equipped with a rectangular steel frame with the following

dimensions: Height 45 – 50 mm, width min. 20 mm, and length min. 1950 mm.

Although the VENDLET systems are suitable for mounting on most beds with the

above dimensions, the VENDLET may not be suitable for mounting on some beds.

Before using a VENDLET system with a client, it is important to assess whether the system is suitable for the given client and whether the situation at hand requires special considerations. For example, it could be necessary to take special precautions if the client is restless in bed.

Likewise, it must be ensured that the caregivers have been trained in the proper use of the VENDLET.

#### Preparations

##### Tools

You need an Allen key 5 and 6 to mount the VENDLET.

##### Overview of bolts, washers and nuts

The following bolts, washers and nuts are included in the delivery:

Button head bolts:

8 pcs of M10 x 20 mm (for mounting brackets)

NOTE:

Replace the M10 x 20 mm button head bolts by M10 x 30 mm bolts if 1 spacer is used.

Replace the M10 x 20 mm button head bolts by M10 x 40 mm bolts if 2 spacers are used.

Replace the M10 x 20 mm button head bolts by M10 x 50 mm bolts if 3 spacers are used.

##### Dimensional requirements, side rails

If the bed is equipped with side rails, these must be removed before mounting the VENDLET. The VENDLET V5S system has been tested and approved to function as side rails in accordance with the requirements of EN60601-2-52.

When mounting the VENDLET you should take the following dimensions into account:

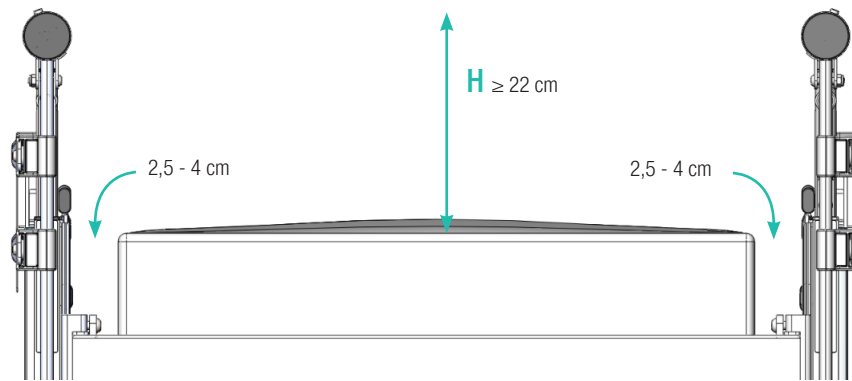

A distance of 2.5 – 4 cm is required between the mattress and the VENDLET on both sides of the mattress. Likewise, it is important that the mattress guides are suitable for the mattress and will hold the mattress in place. If necessary, use spacers to achieve the desired distance, see page 22.

In order to meet the side rail requirements, the upper edge of the bars must be mounted 22 cm above the mattress surface, meaning that the H measure must be at least 22 cm.

distance, see page 23.

**Maximum loads**

The max. user weight for VENDLET V5S and VENDLET V5S Speed Adjust is 200 kg.

The max. user weight for VENDLET Bari is 400 kg.

Since the VENDLET systems are always mounted on beds, it is important to consider the whole solution.



You should always check the maximum load of the bed and ensure that the combined weight of the client, the VENDLET system and any other equipment on the bed never exceeds this limit.

**Attaching a side**

Mount the side with red color code on the bed at the client's right side. Mount the side with blue color code on the bed at the client's left side. Side is determined by the supine position of the bedridden person.

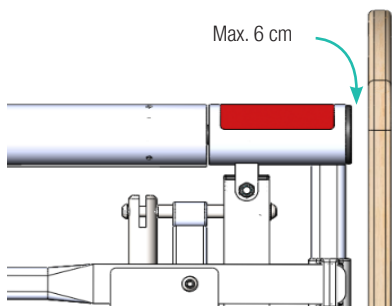
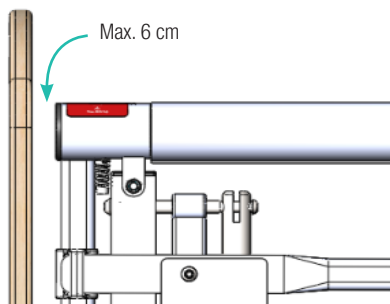

At the head end and the foot end of the bed there must be no more than 6 cm from the board to the VENDLET system. If necessary, use side rail extension to achieve the right

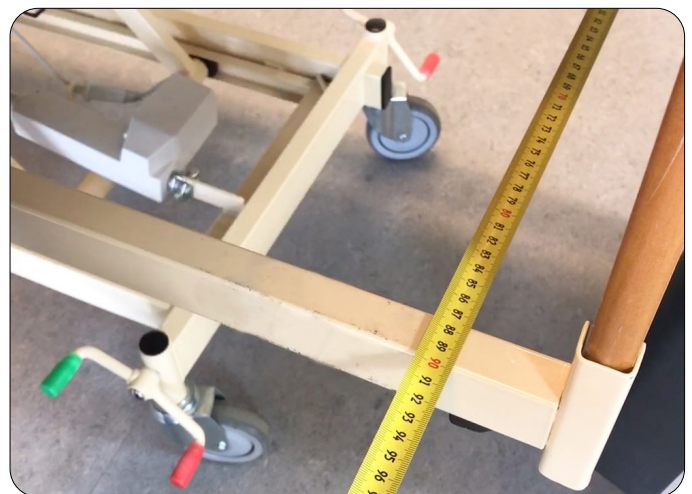

Measure the width of the bed on the outside of the bed frame and the width of the mattress, to assess whether you need spacers for mounting the VENDLET, see page 19



Screw the mounting plate onto the mounting bracket with the top bolt

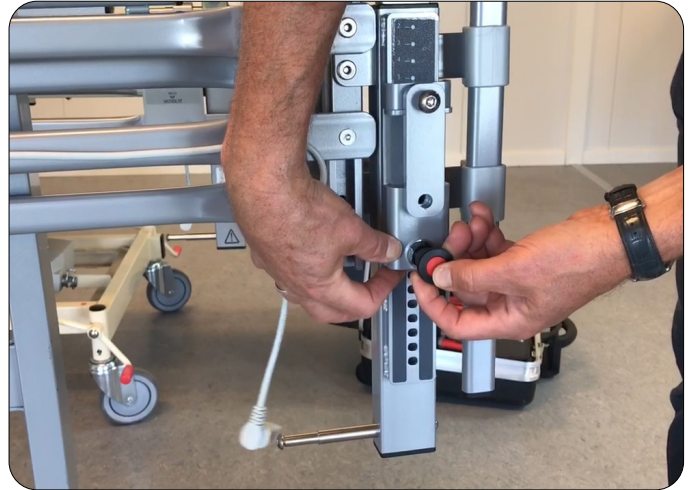

Position the bracket at the required height (can be adjusted later)



Mount the bracket on the VENDLET from the bottom up

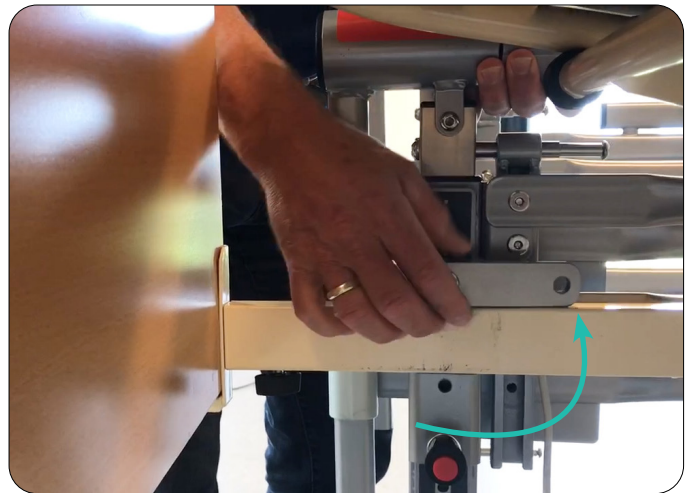

Swing the mounting plate up and place the VENDLET on the bed frame

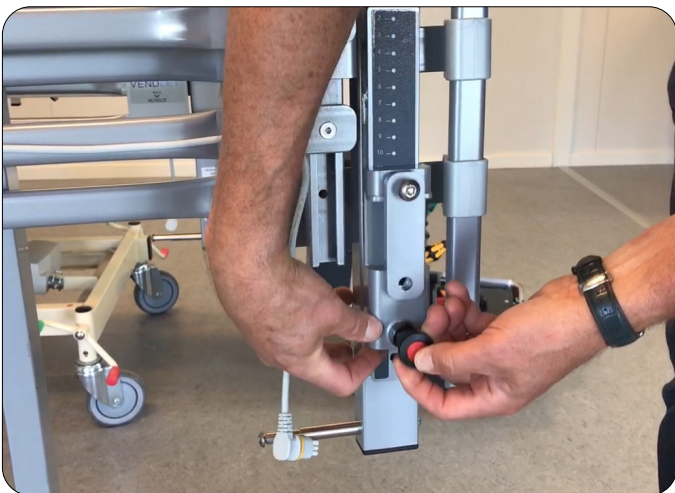

When the bracket encounters resistance the red button is pressed in while the black part is pulled out

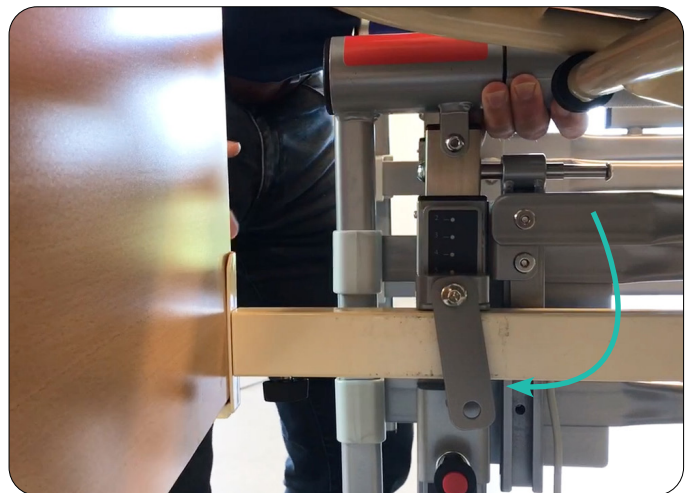

Swing the mounting plate back into place



Adjust the position of the VENDLET system on the bed frame so that there is a distance of 6 cm between the head- and footboard and the VENDLET system

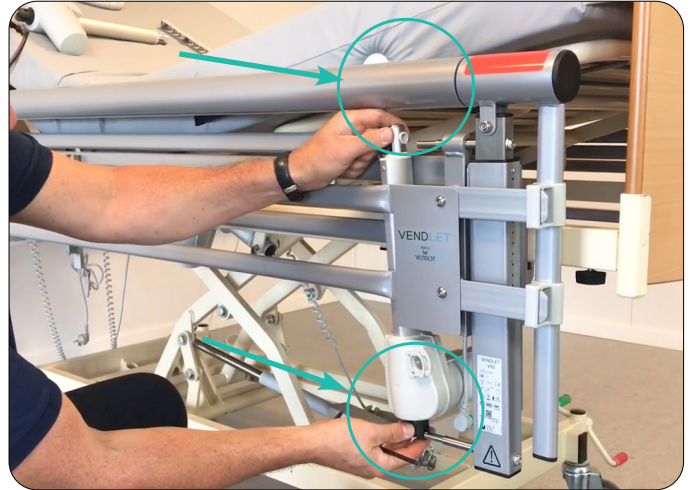

Replace the bolts and tighten one end at a time



Fasten the mounting brackets by tightening both bolts



Connect the actuator cable

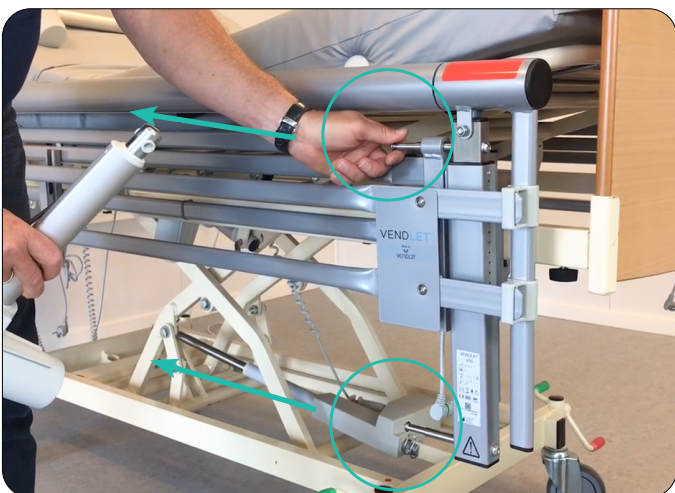

Unscrew the bolts on the actuator fitting at both ends

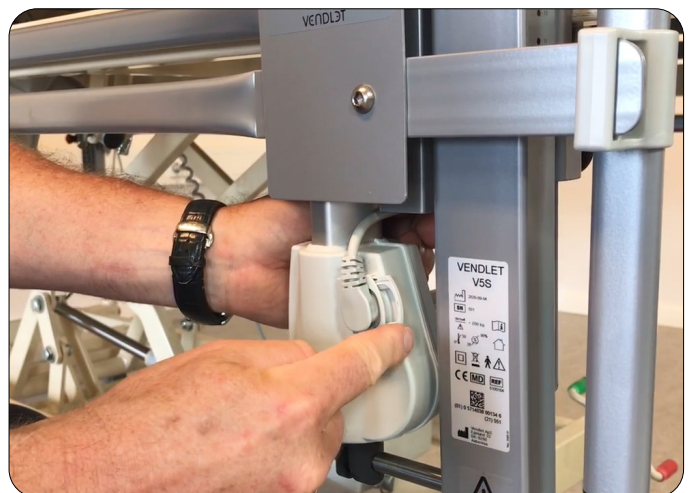

Lock the cable with the locking mechanism



Place the actuator cable behind the actuator with cable ties

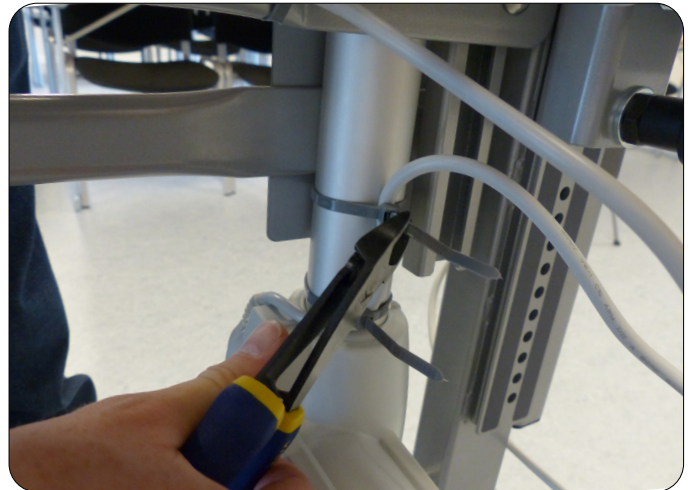

Cut the cable ties

### Height adjustment

Always adjust the height of the VENDLET in accordance with the instructions on page 19 and the height of the mattress.

Use the positioning bolt on the backside of the mounting bracket to adjust the height of the VENDLET. Press in the red button and subsequently pull out on the black part. Now move the actuator fitting up or down to the desired position. Use the scale on the backside or the side of the actuator fitting when choosing position. Let go of the positioning bolt and make sure the bolt locks into position. The lock is in place when the red button comes out.

Always ensure that the positioning bolt is in place and locked by pulling outward and by pressing downward on the actuator fitting. Place all 4 actuator fittings at the same height.

### Adjustment of width of mounting brackets

Use up to 3 10 mm spacers if necessary to pull the mounting bracket away from the bed frame, cf. the "Dimensional side rail requirement" description on page 19.

Mount the spacers on the mounting bracket with the provided button head screws before attaching the mounting bracket to the bed.

Spacers are delivered in sets of four for which you need one bolt set.

The bolt set contains the following items:

4	6 x 6	mm button head	For 1 spacer
4	6 x 16	mm button head	For 2 spacers
4	6 x 26	mm button head	For 3 spacers



One spacer

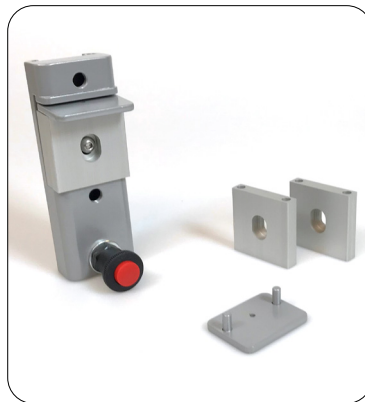

Two spacers and one top plate

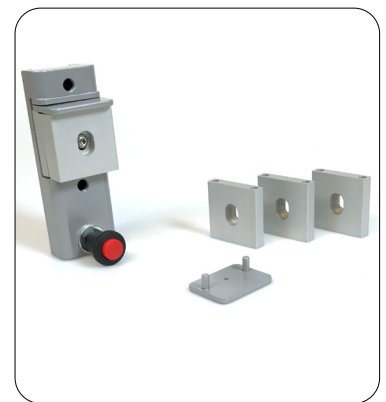

Three spacers and one top plate

When using spacers the button head bolts for mounting brackets must be replaced as described on page 18.

You will need to use top plates if you are using 2 or 3 spacers.

Insert the two pins of the top plate in the holes on the top of the second spacer, with the biggest cutout facing away from the mounting bracket.

Push the spacers towards the mounting bracket contact face and attach them to the mounting bracket using the button head screws.

It is now possible to mount the mounting bracket on the bed frame.

### **Side rail extension**

If it is necessary to reduce the distance between the head or footboard and the VENDLET system, the bar can be extended with a side rail extension. The extension is placed at the foot end.

There can be mounted up to 2 pcs. pr. side. Each side rail extension increases the overall length of the side rail with 7,7 cm.

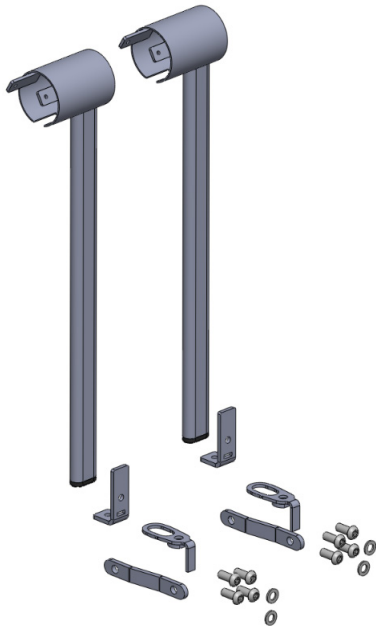

Side rail extension set

### **Height extension set:**

A height extension set will be required when the height of the bars is insufficient, even if the actuator fittings are placed in the top most position.

- A height extension set consists of the following items:
- 4 height extensions
- 4 8 x 40 mm button head bolts
- 4 8 mm self-locking nuts
- 2 height extension support bars

1. Remove nuts and bolts from the bar bracket on both sides.
2. Lift up the bar and place the height extensions on both sides.
3. Attach an 8 x 40 mm button head bolt at the bottom of the height extension and place the height extension support bar with the welding towards the height extension at both ends.
4. Tighten the height extension support bar with a nut in both ends.
5. Remount nuts and bolts at the bar bracket in both sides.

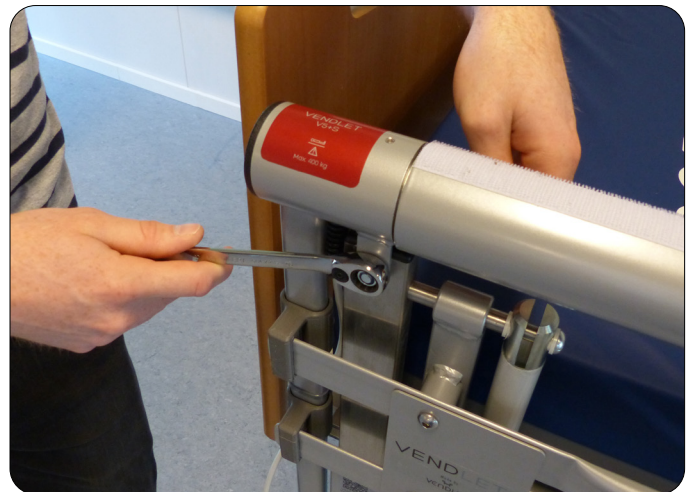

Remove nuts and bolts



Lift up and place the height extensions

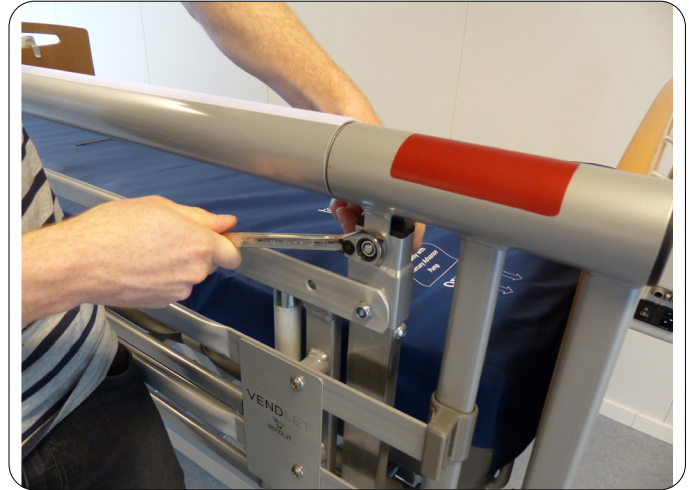

Remount nuts and bolts



## Electrical parts

### *Mounting the control unit*

The control unit is mounted under the bed, usually on the bed frame against the headboard but could also be placed in other locations with free space.

1. Insert the plug into the control unit.
2. Raise the head end of the bed and choose an area under the bed for the control unit. The suspension plate is able to fit bedframes that are between 1,7 and 4,1 cm wide.
3. Adjust the width of the suspension plate to suit the current bed frame. Tighten the suspension plate around the bed frame with the two fingerscrews.
4. The suspension plate will not fit all types of beds. If it is not possible to mount the suspension plate anywhere the control unit must be attached with cable ties.

### *Connecting the hand control*

Connect the hand control to the control unit in the plug by this symbol  on the control unit. It is possible to connect an extra hand control in the plug with this symbol .

The hand control should always hang on the outside of the bed such as on the outside of the headboard.

The hand control should be connected before the actuator and power cables are connected.

In case you need to replace a faulty hand control, begin by unplugging the power cable, replace the hand control and then reconnect the power cable to the mains outlet.



Insert the bolt and place the height extension support bar



Attach the height extension support bar





Insert the plug into the control unit



The hand control is connected to the control unit



Loosen the screws on the suspension plate



The hand control is connected to the control unit

### ***Connecting the cables to control unit***

The next step is to connect the actuator cables.

The red side actuator cables have plugs with green O rings; these are connected to the green control unit colour codes.

The blue side actuator cables have plugs with yellow O rings; these are connected to the yellow control unit colour codes.

The plugs on the blue bar motor cables are fitted with a blue O ring; these are connected to the blue control unit colour code.

The plugs on the red bar motor cables are fitted with a red O ring; these are connected to the red control unit colour code.

### ***Connecting the power cables***

The last step is to connect the control unit power cable to an easily accessible 230V mains plug. The green diode on the control unit illuminates when the power is turned on.

Keep all cables away from the floor and the moving parts of the bed. Once the mounting is complete, all loose cables must be wrapped around the control unit mounting fixture cable guides and secured to prevent them from falling on the floor or getting pinched by the moving parts of the bed. The cables can also be attached to the bedframe with cable ties next to the control unit.



Proper plug location



All cables must be kept away from the floor

### Attaching the sheets

Please refer to page 14 for instructions on how to attach the sheets.

### Quick Guide Location

The quick guide should always be placed where it will be visible from the bed and in proximity to the bed.

### Additional Accessories

#### Speed adjustment

It is possible to upgrade a VENDLET V5S to a VENDLET V5S Speed Adjust. It requires the purchase of a new hand control and perhaps a new control unit. Please, contact Vendlet ApS for more information.

#### Battery backup

If VENDLET is to be used in places where it can not always be connected to the power system, it is possible to attach a battery.



#### Under bed light

Under bed light can be connected and is operated by the hand control.



#### Height restriction bracket

On some bed types the VENDLET system can conflict with the bed wheels or brake when the bed is lowered. The height restriction bracket ensure that the bed can not be lowered too much to create a conflict.



The height limiter can be mounted on all beds with the LINAK LA31 height adjustment motor, including:

- Invacare: SB750, SB750W, SB755 (85 and 90 cm), SB900 (2 units), SB 910 (2 units)
- Comfort System
- KR Opus

#### Height restriction switch for Guldmann GB4

The height restriction bracket can not be used for the Guldmann GB4 care bed. Instead, this height restriction switch must be used for this type of bed.



#### Actuator turn fitting

The actuator turn fitting makes it possible to turn the actuator 90° so that the plastic housing of the actuator does not bump against the bed's brakes, wheels, etc.



#### Bracket for Volker 3080

You need to mount special brackets on a Volker 3080 bed before you can mount a VENDLET system.



#### Bed frame bracket

Some bed frames have welding and/or rounded corners on the bed frame which makes traditional

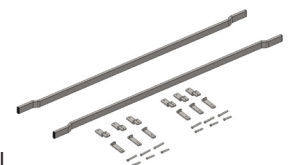

mounting of the VENDLET complicated. Adequate space for mounting the VENDLET is ensured using the Bed Frame Bracket.

**Side rail bumper**

In certain situations, it can be necessary to protect the restless and agitated clients from bumping into the side rails. The side rail bumpers are easily mounted, and works up and down integrated with the side rails.



**Transport and mounting trolley**

The transport and mounting trolley for VENDLET provides better protection of the VENDLET during transport and simplifies the entire mounting and transport situation.



You can see more about all accessories on our webpage.

**Final Inspection Checklist**

Always perform a final inspection after completing the installation. The final inspection is carried out by following the checklist below. The list may also be downloaded at [www.vendlet.com](http://www.vendlet.com).

The desired result of the procedure is a situation where all "Yes" checkboxes have been marked. If one or more "No" checkboxes have been marked, the matter should be investigated and you should consider stopping using the VENDLET until the situation has been remedied and a solution found.

Final inspection checklist	Yes	No
Was the VENDLET mounted by a person with relevant training?		
Is the combined weight of the client, the VENDLET and any other equipment on/in the bed below the max. load of the bed?		
Have the side rail dimensioning requirements been met?		
Are all actuator fittings mounted at the same height and at the same distance from the bed frame?		
Do both bars run freely up and down?		
Do both bars slacken and pull in the sheet?		
Does the timer activate when the button is pushed twice within 2 seconds?		
Does the timer turn off after 90 seconds of idle time?		
Is the control unit securely suspended?		
Are all cables securely attached to the bed with cable ties and away from the moving parts of the bed?		
Are all loose cables off the floor and wrapped around the cable guides on the control unit suspension plate?		
Is the slide sheet fitted on top of the mattress and properly attached?		
Is the turning sheet fitted in such a way that it turns properly on the bars?		
Is the quick guide visible and located near the bed?		
Is the VENDLET manual available?		
Have the caregivers been instructed on the use of the VENDLET and its functions?		
Has the VENDLET system been signed up for an annual service check?		

## Dismounting, Storage & Remounting

### Dismounting

The VENDLET may be dismounted and transferred to another bed.

1. Remove the turning sheet and the slide sheet.
2. Lower the VENDLET bars.
3. Disconnect the power cable from the outlet.
4. Then the VENDLET can be removed by the same procedure as described in the mounting section on page 33-35, ie:
  - Remove the two strips that hold the cables in place on all four actuators.
  - Dismount the actuator.
  - Strap the VENDLET together so that the side rail can not run up and down.
  - Loosen the bolts in the mounting plates and turn aside to lift VENDLET off the bed frame.

### Storage

The VENDLET should be stored in a dry location.

Temperature: -10°C - +50° C

Relative air humidity: 20% - 90% @ 30° C. No condensation.

Atmospheric pressure: 700 - 1060 hPa.

### Remounting

Follow the procedure described in this manual if remounting is required.

Before the mounting, you should check all VENDLET parts for damage and that the date of the annual service check has not been exceeded.

## Maintenance/Check

### Annual check

The VENDLET system must be serviced annually by a person with relevant training. This check will ensure that the safety issues pertaining to the VENDLET system are in compliance with the standard as well as a long service life.

The annual check includes the following:

#### Mechanical parts

	Check for signs of damage and crooked fittings or brackets and missing parts.
	Check the bars and support bars for dents/deformations.
	Check whether the bar velcro tapes are attached and in good condition.





#### Sheets

	Is the turning sheet in good condition?
	Is the slide sheet in good condition?

#### Functional tests

	Do all bolts and nuts match the parts list and are they evenly tightened? Is there a 1 mm clearance between the end of the bar and the slide sleeve of the top fitting?
	Does the mounting meet all side rail dimension requirements?
	Check whether it is possible to raise and lower the bars freely and in parallel. It might be necessary to remount the brackets to ensure proper height and width.
	Check whether the VENDLET works as intended when the hand control is activated.

**Electrical parts**

<b>Control unit no.:</b>			
Check the control unit including plugs and mounting fittings for signs of damage.			
Check whether the timer deactivates after 90 seconds of idle time.			
<b>Transformer no.:</b>		<b>Hand control no.:</b>	
Check the transformer for signs of damage.		Check the hand control, cables and mounting fixtures for signs of damage.	
Check all cables, plugs, and relief cables for signs of damage.		Check the functioning of all buttons and whether the green diode is illuminated when the system is active.	
Check whether the green diode is illuminated.		Check all plugs, cables, and relief cables.	
When using an extension cable, check whether the cable has the necessary quadrant (1.0 mm <sup>2</sup> ).		Check the stop function.	
<b>Bars</b>	<b>Red side</b>	<b>Blue side</b>	
Check the motors for signs of damage.			
Check all cables, plugs, and relief cables for signs of damage.			
Check whether the bar can be operated manually when the motor is disconnected from the control unit.			
Check whether the motor has full pulling power when you press the  /  and reduced pulling power when you press the  /  by stopping the bar with your hand.			
<b>Actuators</b>			
Check the plastic covers for signs of damage.			
Check all cables, plugs, and relief cables for damage. Check whether the cables are properly secured.			
Check whether the cables are properly secured to the bed frame with cable ties.			
Check the slide function – lubricate, if necessary.			

**Troubleshooting**

Problem	Checklist
VENDLET does not work	Has the power been turned on?
	Is the green diode on the control unit under the bed illuminated?
	Is the green diode on the hand control illuminated?
	Are all cables properly mounted and intact?
	Replace the hand control.
	Reset the system by simultaneously pressing the two top buttons on the hand control. You will hear 10 rhythmic beeps. Press and hold the buttons until the beeping stops.
	Contact a person with relevant training.
The bar starts but stops pulling immediately afterwards	Does the client weigh more than max. user weight?
	Is part of the mattress or blanket rolled onto the bar with the sheet?
	Is the turning sheet attached correctly?
One of the bars does not work.	Is the cable from the bar intact and correctly mounted?
	Switch the plugs of the two bars. If the same bar still does not work, then the motor of that bar is defective. If the other bar is not working, then the hand control or the control unit is defective. Replace the hand control. If this does not solve the problem, replace the control unit.
	Reset the system by simultaneously pressing the two top buttons on the hand control. You will hear a series of rhythmic beeps. Press and hold the buttons until the beeping stops.
	Replace the bar motor.
	Contact a person with relevant training.
One or both bars will not work when a load is applied	Does the sheet run over the bar, cf. page 24 of the user manual? If the sheet runs under the bar, the motor disconnects when used. This is a safety feature.
	Switch the plugs of the two bars. If the same bar still does not work, then the motor of that bar is defective. If the other bar is not working, then the hand control or the control unit is defective. Replace the hand control. If this does not solve the problem, replace the control unit.
	Replace the bar motor.
	Contact a person with relevant training.
One of the bars will only move in one direction	Is the plug properly connected to the control unit and the actuator?
	Is the cable intact?
	Switch the plugs of the two bars. If the same bar still does not work, then the bar motor is defective. If the other bar is not working, then the hand control or the control unit is defective. Replace the hand control. If this does not solve the problem, replace the control unit.
	Reset the system by simultaneously pressing the two top buttons on the hand control. You will hear a series of rhythmic beeps. Press and hold the buttons until the beeping rhythm changes.
	Replace the bar motor.
	Contact a person with relevant training.
The hand control buttons are not working	Is the plug properly connected to the control unit?
	Is the cable intact?
	If the actuator still does not work, try changing the channel. Replace the actuator if this does not solve the problem.
	Reset the system by simultaneously pressing the two top buttons on the hand control. You will hear a series of rhythmic beeps. Press and hold the buttons until the beeping rhythm changes.
	Replace the hand control.
	Contact a person with relevant training.

One or more actuators will not go up or down	Is the plug properly connected to the control unit?
	Is the cable intact?
	If the actuator still does not work, try changing the channel. Replace the actuator if this does not solve the problem.
	Reset the system by simultaneously pressing the two top buttons on the hand control. You will hear a series of rhythmic beeps. Press and hold the buttons until the beeping rhythm changes.
One or more actuators / actuator fittings will not move entirely down	Contact a person with relevant training.
	Are the actuator fittings perpendicular to the bed frame?
	Have the side rail dimensioning requirements been met, cf. page 31-32? If not, the free movement of the actuator fittings may be affected.
	Dirt, dust etc. may obstruct the sliding function of the actuator fitting. Clean the actuator fitting and lubricate it with silicone spray.

## Repairs

Only a limited number of VENDLET system components need regular replacement. On the next pages, we will explain the more general repairs. Please do not hesitate to contact us or our consultants if you need assistance or guidance or to perform repairs or troubleshooting.

All repairs must be carried out by a person with relevant training.

### Replacing the motor in a bar

1. Raise the bar and remove the turning sheet from the bar on which the motor is to be replaced.
2. Disconnect the power cable from the mains outlet.
3. Disconnect the motor bar cable from the control unit and remove the bar from one of the fittings (you can also choose to disconnect the bar in both ends).
4. Remove the Allen screw at the motor end of the bar and pull the motor out.
5. Unscrew the small pivot screw on the motor fitting and remove it.
6. Mount the motor fitting on the new motor and attach it using the pivot screw.
7. Place the motor inside the bar and attach it using the Allen screw you removed earlier.
8. Mount the bar on the two actuator fittings and connect the cable to the control unit. Remember the plastic fittings.
9. Reconnect the power cable to the mains outlet.
10. Reset the system by simultaneously pressing the two top buttons on the hand control. You will hear a series of rhythmic beeps. Press and hold the buttons until the beeping stops.
11. Check whether the bar is working properly.



Dismount the bar from the actuator fitting

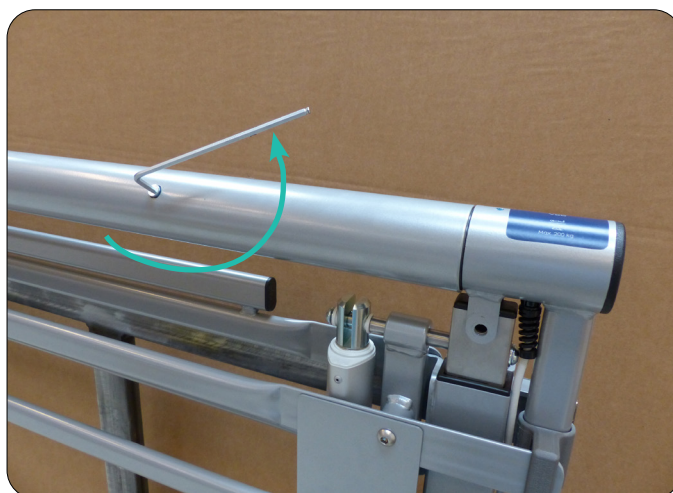

Remove the Allen screw

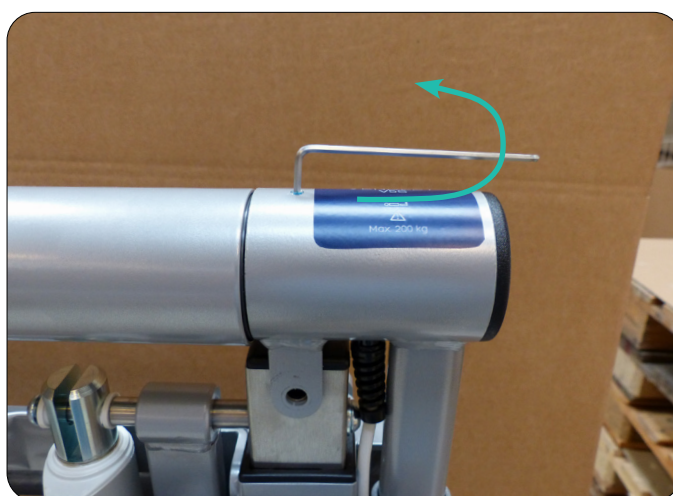

Remove the pivot screw

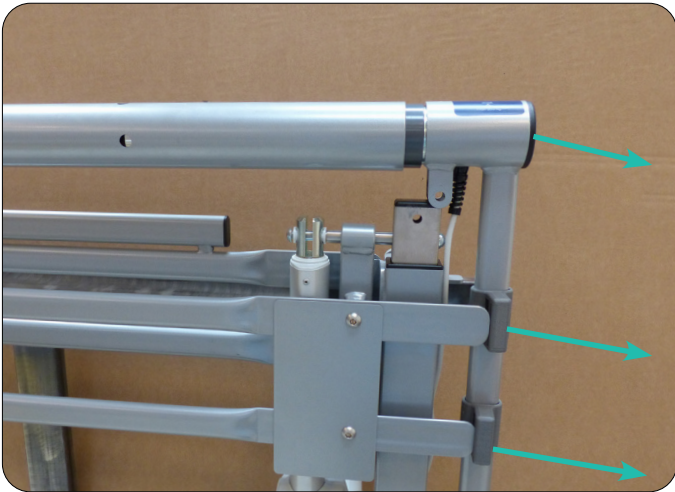

Remove the motor bracket and motor

using the two Allen screws.

8. Secure the actuator cable with two new cable ties and route it along the inside of the bed frame to the control unit. Use cable ties to secure the actuator cable along the bed frame in such a way that the cable will not get caught by the moving parts of the bed.
9. Reconnect the power cable to the mains outlet.
10. Reset the system by simultaneously pressing the two top buttons on the hand control. You will hear a series of rhythmic beeps. Press and hold the buttons until the beeping stops.
11. Check whether the actuator is working properly.



Change the motor



Remove the Allen screws and free the actuator

### Replacing the actuator

1. Disconnect the power cable from the mains outlet.
2. Disconnect the cable from the control unit.
3. Disconnect the actuator cable from the control unit and release it from the bed, allowing it to hang freely.
4. Remove the 2 Allen screws securing the actuator to the actuator fitting and remove the actuator.
5. Remove the actuator cable from the defective actuator if you want to re-use the cable. The actuator cable is attached to the actuator with a locking device. Release the locking device by pressing a small straight blade screwdriver against the side of the locking device on both sides.
6. Remove the actuator cable from the defective actuator and install it on the new actuator.
7. Mount the new actuator on the actuator fitting and attach it



Release the locking device

## Replacing the velcro tape on a bar

The bar velcro bands are wearing parts that wear out over time. The velcro bands will have to be replaced when they no longer properly secure the turning sheet.

1. Release one end of the velcro band and pull it off the bar.
2. Use a sharp knife to remove the glue residue. Clean and degrease the bar.
3. Glue the new velcro strip onto the bar. Once the velcro tape is secured, run a hard roller over the velcro tape several times to ensure optimal adhesion to the bar and remove air pockets from the underside of the velcro tape.
4. You should always use original velcro tape from DHG.

## Spare Parts

All individual components are delivered as complete units as spare parts.

Please contact DHG for further information.

## Technical Data

In accordance with the Medical Device Regulation (EU) 2017/745, VENDLET is a class I product.

	VENDLET V5S VENDLET V5S Speed Adjust	VENDLET Bari
Product no.	6100000 / 6100050	6100150
Max. user weight	200 kg	400 kg
Power supply:		
Transformer	Class 1	Class 1
Mains supply	230 Volt AC/50 Hz	230 Volt AC/50 Hz
Power rating	Up to 200 VA	Up to 200 VA
Output voltage	24 Volt DC	24 Volt DC
IP class	IPX6	IPX6
Intermittence	10%	10%
Battery (optional):	1,2 AH / 24 Volt DC	1,2 AH / 24 Volt DC
IP class	IPX6	IPX6
Control unit:		
Output voltage	24 Volt DC	24 Volt DC
IP class	IPX6	IPX6
Intermittence	10%	10%
Weight:		
Total system	approx. 58 kg	approx. 58 kg
Red side incl. actuator	27 kg	27 kg
Blue side incl. actuator	27 kg	27 kg
Control unit	3,9 kg	3,9 kg
Length:	200 cm	200 cm
Width:	May be adapted to beds between 70 and 140 cm	
Expected service life	10 years	10 years
Noise level max. load	65 db(A)	65 db(A)
Turning sheet:		

Regular length and width	350 cm / 180 cm	350 cm / 180 cm
Material	100 % cotton	100 % cotton
Slide sheet:		
Regular length and width	210 cm / 95 cm	210 cm / 95 cm
Material	100% nylon	100% nylon
System service check	Annually	Annually

## Environmental Conditions & Disposal

### Environmental conditions

Operation:	
Temperature	5 – 40 °C
Air humidity	20 – 90% at 30°C – no condensation
Atmospheric pressure	700 – 1060 hPa
Storage:	
Temperature	-10 - +50 °C
Air humidity	20 – 90% at 30°C – no condensation
Atmospheric pressure	700 – 1060 hPa
Transport:	
Take the necessary precautions to protect the electric components against rough jolts, shocks etc.	
After transportation in low temperatures, the actuators and motors in the bars might work irregularly until they have been warmed up to normal room temperature.	

### Power consumption

	VENDLET V5S VENDLET V5S Speed Adjust		VENDLET Bari	
Standby		5 Watt		5 Watt
Working	Bars raise / lower	190 Watt	Bars raise / lower	190 Watt
	Tighten sheet (without person)	50 Watt	Tighten sheet (without person)	50 Watt
	Slacken sheet	20 Watt	Slacken sheet	20 Watt
	Moving a person at 90 kg	115 Watt	Moving a person at 90 kg	115 Watt
	Moving a person at 200 kg	150 Watt	Moving a person at 400 kg	220 Watt

### Disposal

Do not discard a VENDLET with general household waste. On disposal of a VENDLET, DHG recommends that the system be divided into individual parts and components with a view to recycling.

All mechanical steel components may be disposed of as metal parts.

The control unit must be disposed of as electronic waste. Furthermore, it may be divided into metal waste, cable waste,



electronic waste, and reusable plastic.

The actuators may be disposed of as electronic waste. Furthermore, they may be divided into metal waste, electronic waste, and reusable plastic.

The hand control may be disposed of as electronic waste. Furthermore, it may be divided into cable waste, electronic waste, and reusable plastic.

The turning sheet and the slide sheet should be disposed of as combustible waste.

**This Page is Left Intentionally Blank**

**This Page is Left Intentionally Blank**



Moving Health Forward

**PRESSURE ULCER PREVENTION**  
**SAFE MOVING & HANDLING**  
**SPECIALIST THERAPIES**  
**BATHROOM SAFETY**  
**RENTAL & SERVICE SOLUTIONS**



Direct Healthcare Group Ltd  
Withey Court, Western Industrial Estate  
Caerphilly, United Kingdom  
CF83 1BF

T: +44 (0) 800 043 0881  
F: +44 (0) 845 459 9832  
E: [info@directhealthcaregroup.com](mailto:info@directhealthcaregroup.com)

**EC** **REP**

**EU Authorised Representative, Importer, and Distributor:**

Direct Healthcare Group Sverige AB,  
Torshamnsgatan 35, SE-164 40, Kista  
Sweden  
T: +46 (0) 8 557 200

**Australian Sponsor:**

Direct Healthcare Group Pty Ltd.,  
68 Howe Street, Osborne Park,  
Western Australia 6017  
T: +61 (0) 423 852 810



LIT-00154 Issue 1  
Date: June 2022

[DHG-HEALTHCARE.COM](http://DHG-HEALTHCARE.COM)