

VENDLET®

BASIC



MANUAL



Declaration of Conformity

Vendlet ApS hereby declare that the devices mentioned below comply with the Medical Device Regulation (EU) 2017/745.

Legal manufacturer: Vendlet ApS, Egelund 33, 6200 Aabenraa, DK
SRN:DK-MF-000002044

Device: Product no. and name UDI-DI:
6200000 VENDLET Basic 05714038001056

Basic UDI-DI: 05714038001049EU

Description: Electromechanical turning aid for handling and turning patients
in bed.

Classification, rule: Class I acc. to rule 1 and 13 of annex VIII in (EU) 2017/745.

The product complies with the following standards: EN 60601-2-52:2010 Medical electrical equipment – Part 2-52:
Particular requirements for basic safety and essential performance of medical beds

60601-1-2:2015 Medical electrical equipment. General requirements for basic safety and essential performance - Collateral
Standard: Electromagnetic disturbances - Requirements and test

EN 60529+A1:2002 Degree of protection provided by enclosures
(IP Code) - Washability

This declaration of conformity is valid from the date of signature.

Aabenraa, 29.10.2020

A handwritten signature in blue ink, appearing to read "P. Maindal".

Peter Maindal
Director

Congratulations on your new VENDLET.

The VENDLET is used for handling bedridden clients, for example:

- turning the client to lateral, prone or supine positions
- moving the client from one side of the bed to the other
- repositioning the client up in the bed

This manual covers the VENDLET Basic.



Max. user weight is 150 kg

The instructions in this manual must be followed. Vendlet ApS shall not be liable should the VENDLET Basic be used, modified, or assembled in a way that is not described in this manual.

This manual is divided into three parts:

Part 1 contains general information that is useful to everyone responsible for the purchasing, examination, use, assembly, and maintenance of the VENDLET Basic.

Part 2 is a user manual containing information about the operation and daily maintenance of the VENDLET Basic.

Part 3 is a technical manual containing information about the assembly, maintenance, and service of the VENDLET Basic.

PART 1 - General information

INTENDED USE	7
Target group	7
<i>Independent living</i>	7
<i>Staff</i>	7
<i>Environment</i>	7
PRODUCT DESCRIPTION	7
How VENDLET Basic works	8
Warnings	9
Stop button	9
Accessories	9
BED AND MATTRESS COMPATIBILITY	10
Bed requirements	10
Mattress requirements	10
WARRANTY AND SERVICE LIFE	10
IN THE EVENT OF AN INCIDENT	10
SYMBOLS	11

PART 2 - User manual

OPERATION	12
How to use VENDLET Basic	12
<i>Turning</i>	12
<i>Moving from one side of the bed to the other</i>	13
<i>Repositioning the client up in the bed</i>	14
<i>Applying a sling</i>	15
<i>Prone position</i>	16
<i>Side rail</i>	17
Using VENDLET Basic in combination with bed functionality	17
Pressure-relieving mattresses	17
Incontinence	17
Urine bag and drainage tube	17
ATTACHING THE SHEETS	18
Slide sheet	18

Turning sheet	19
<i>Attaching the turning sheet before use</i>	19
<i>What should I do if the turning sheet is rolled askew on the bars?</i>	19
<i>Changing the turning sheet on an occupied bed</i>	20
EVACUATION	21
Evacuation via the foot end of the bed	21
Evacuation via the side of the bed	21
DAILY MAINTENANCE	22
Daily inspections	22
Cleaning and washing instructions	23
<i>Cleaning of electrical and mechanical parts</i>	23
<i>Washing instructions, slide sheet</i>	23
<i>Washing instructions, turning sheet</i>	23
Troubleshooting - daily use	24

PART 3 - Technical manual

UNPACKING	25
Parts list	25
MOUNTING	26
Preparations	26
<i>Tools and bolts</i>	26
<i>Dimensional requirements, side rails</i>	26
<i>Maximum loads</i>	27
Mounting	27
<i>Attaching a side</i>	27
<i>Height adjustment</i>	29
Electrical parts	30
<i>Mounting the control unit</i>	30
<i>Connecting the control unit</i>	31
<i>Connecting the power cables</i>	32
Attaching the sheets	32
QUICK GUIDE LOCATION	32
FINAL INSPECTION CHECKLIST	33
DISMOUNTING, STORAGE AND REMOUNTING	34

Dismounting	34
Storage	34
Remounting	34
MAINTENANCE/CHECK	35
Annual check	35
<i>Electrical parts</i>	<i>35</i>
<i>Mechanical parts</i>	<i>35</i>
<i>Sheets</i>	<i>35</i>
<i>Functional tests</i>	<i>35</i>
Replacements of parts	35
TROUBLESHOOTING - TECHNICIANS	36
TECHNICAL DATA	37
Battery backup	37
<i>Recharging during storage</i>	<i>37</i>
<i>LED functionality</i>	<i>37</i>
<i>Buzzer functionality</i>	<i>37</i>
Power consumption	37
ESSENTIAL PERFORMANCE	38
ENVIRONMENTAL CONDITIONS AND DISPOSAL	38
Environmental conditions	38
Disposal	38

PART 1 - General information

INTENDED USE

VENDLET Basic may be used for moving clients to a lateral, prone, or supine position, from one side of the bed to the other, or, to reposition them further up in bed.

VENDLET Basic protects the caregiver from physical strain and heavy lifting in connection with the handling of immobile clients. Clients are turned/handled by pressing a hand control whereby the caregiver may support the client and ensure their correct and comfortable positioning. This provides room for increased awareness in the care, which boosts employee job satisfaction and client well-being.

To the client, the turning process becomes uniform and steady as the sheet supports the body over its full length.

Target group

The target group is adult clients who are being cared for, dressed, washed etc. in bed. This will often be clients who are lifted in and out of bed or clients who are mobilized using a standing aid. Hence, the user will typically be clients with few physical and/or cognitive resources and palliative clients.

VENDLET Basic is also suitable for clients at risk of developing pressure ulcers. The uniform and steady transfer with the sheet minimizes friction and the associated shear that can damage the tissue and cause pressure ulcers. Furthermore, VENDLET Basic is often seen to have a positive effect on clients suffering from spatial awareness.

The VENDLET Basic is intended for adult clients weighing between 0 and 150 kg, with a height above 146 cm and a body mass index (BMI) above 17.

There are no contraindications for the use of VENDLET Basic. However, prior to the first use of VENDLET Basic, it is important to assess whether VENDLET Basic is suitable for the client in question. It may be necessary to take special precautions, for example if a client is very restless in bed or has an untypical anatomy.

Independent living

VENDLET Basic is not designed to be operated by the clients themselves. However, if a risk assessment made by the responsible healthcare professional evaluate, that the client is able to take part in the moving and handling procedures, e.g. by operating the hand control, this can be a part of the rehabilitative effort.

The risk assessment should evaluate the clients physical, cognitive and palliative resources. The risk assessment must be available by the bed and must be updated on a regular basis.

Vendlet cannot be held responsible for the risk assessment or conclusions based on this.

Staff

Before using VENDLET Basic, it must be ensured that the caregivers/operators have read "Part 2 – User manual" and that the manual and quick guide are available by the bed.

Environment

VENDLET Basic can be used in all application environment (1-5), e.g. hospitals, nursing homes and domestic / private homes.

PRODUCT DESCRIPTION

VENDLET Basic consist of two bars fitted with motors. The bar on the left side of the client has a blue color marking and the bar on the right side of the client has a red color marking.

Each motorized bar has a groove which makes it possible to attach the edge strip of the turning sheet to the bars. When the bars are running, the turning sheet will be dragged between the two bars, making it possible to move it from side to side.

A slide sheet is inserted under the turning sheet in order to reduce the friction of the turning sheet against the mattress.

The bars are raised manually by lifting the bar until the corner post clicks leaving the bar locked in the upper position. The bar can be raised one end at the time or simultaneously by a grip on the middle of the bar.

The bars are lowered manually by lifting the end of the bar while clicking the grey button at the top of the corner post. This releases the bar which can now be lowered.

To allow the individual adjustment of VENDLET Basic to any bed and mattress, the mounting brackets are height-adjustable.

Furthermore, VENDLET Basic consist of a control unit and a hand control. The control unit is placed underneath the bed, normally on the base frame.

When the bars are raised VENDLET Basic works as side rails.

VENDLET Basic is telescopic in length and can be extended from 200 to 220 cm.

PART 1 - General information

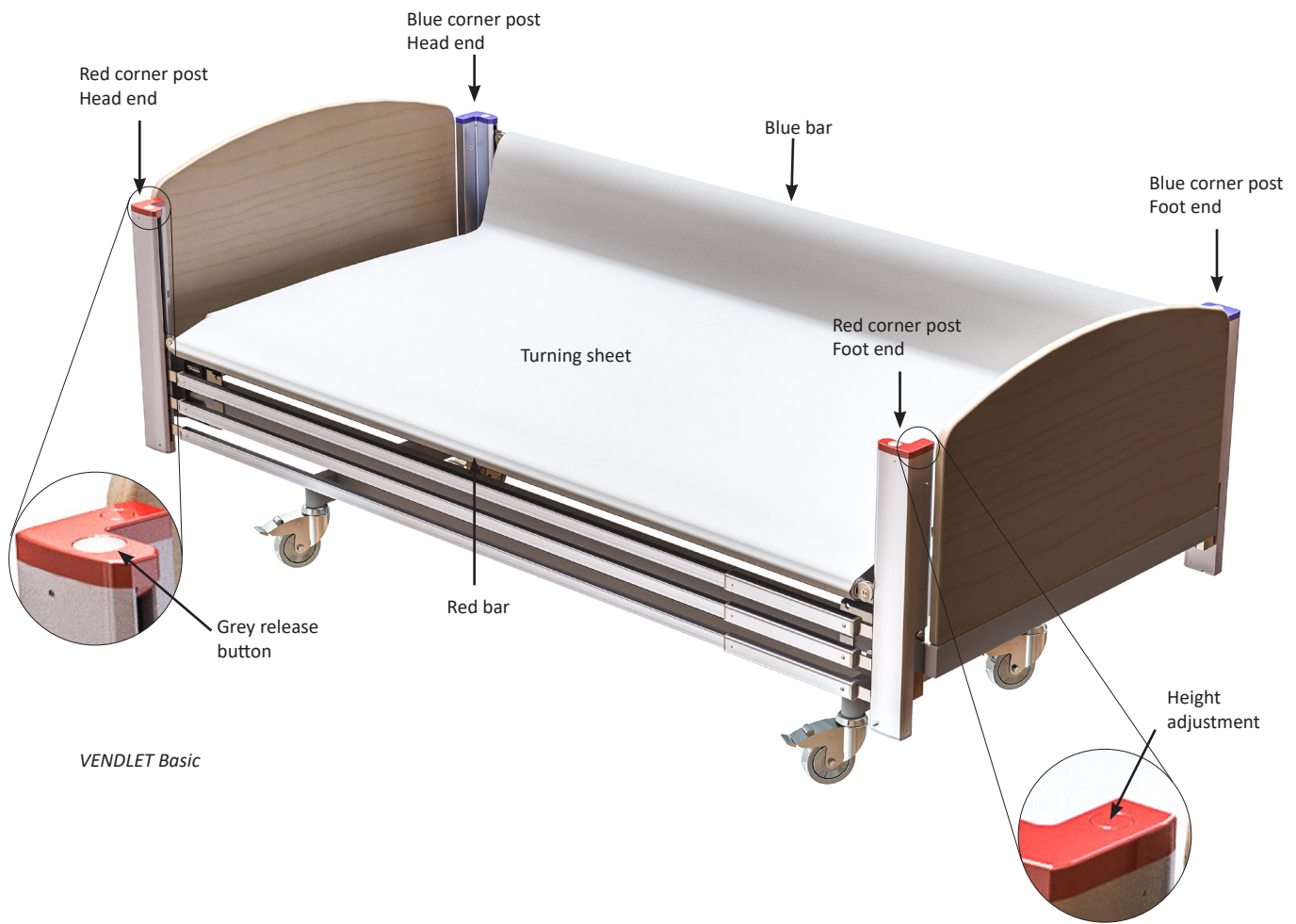

How VENDLET Basic works

VENDLET Basic is switched on by double-clicking the  on the hand control. VENDLET Basic produce a “beep” upon activation and the green diode over the power symbol turns on.

When VENDLET Basic hasn’t been used for 90 seconds, the system produces a “beep-beep” sound, the diode turns off, and then VENDLET Basic is turned off.



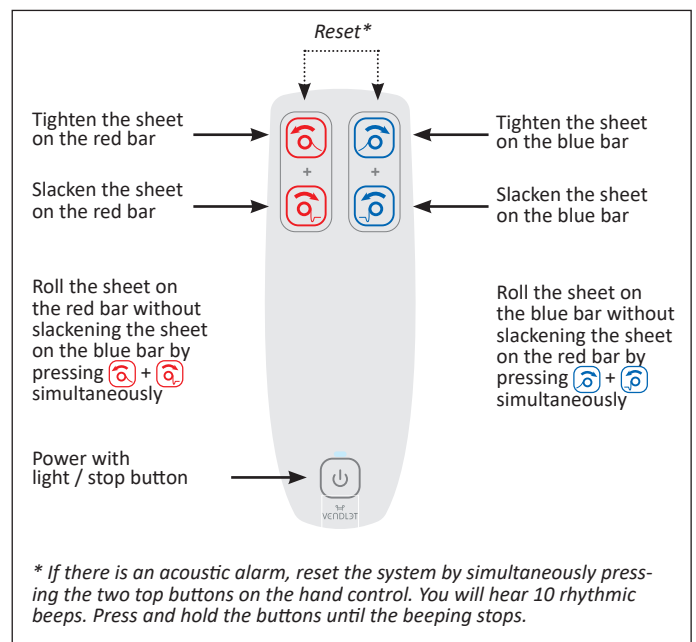

When VENDLET Basic is turned on, the bars can be turned in both directions. The colour coding on the bars relates to the colours on the hand control buttons.

Press and hold the individual buttons long enough to obtain the desired operation; the motors will stop when the button is released. Likewise, you may stop an activated function by clicking the .

VENDLET Basic hand control



Watch a video on how the hand control works on our webpage www.vendlet.com or scan the QR-koden.

The bars on the VENDLET Basic turn together. If the red bar pulls, the blue bar starts slacking, and vice versa. If you don’t want the sheet to be slacked at the opposite bar, press both  +  simultaneously or  +  simultaneously.

PART 1 - General information

When the bar is up on the side where the turning sheet is being tightened, the client will be turned. If, on the other hand, the bar is down on the side where the turning sheet is being tightened, the client will be moved towards the edge of the bed. These fundamental principles provide you with a number of ways to move and/or transfer clients. See the "How to Use the VENDLET" section in "Part 2 – User Manual" for further details.

VENDLET Basic can be operated by only one caregiver.

Warnings



As it is recommended that the client does not operate VENDLET Basic themselves, the hand control must be placed on the outside of the bed before leaving the client.



The client must not operate VENDLET Basic on their own unless a qualified risk assessment has been carried out. Vendlet ApS cannot be held responsible for the risk assessment or conclusions based on this.



Always, keep focus on the client when using VENDLET Basic.



If the client has long and loose hanging hair, the hair could in some situations be rolled onto the bar. Therefore, long loose hair should be collected before moving and handling the client.



Be aware, that the client does not get too close to the edge of the bed, as there is a risk of falling out of the bed.



Do not use VENDLET Basic if the bars can not be elevated properly.



Lowering the bed to a very low position may leave the corner post close to the floor. Consequently, you should not place your feet under the corner posts.



The client must not hold on to the edge of the turning sheet or bar during the transfer. If the client is restless and needs something to hold on to, we recommend they get a handle such as a MANULET Mono Grip.

Stop button



The power button  also functions as a stop button.

If the hand control button controlling the tightening of the sheet fails, the operation can be stopped by pressing the  button.

Accessories

Additional hand control:

An additional hand control can be connected if a hand control is required on both sides of the bed.

Wider sheets:

Wider turning sheets and slide sheets are also available if VENDLET Basic is to be used on wider beds.

Battery backup:

Battery backup is available to operate VENDLET Basic without a connection to the supply network. See page 37 for technical information on the battery backup.

BED AND MATTRESS COMPATIBILITY

VENDLET Basic is intended for mounting on a wide range of hospital and care beds and with a wide range of mattresses.

The following bed and mattress requirements must be met.

Bed requirements

The bed must meet the EN 60601-2-52 standard or the expired EN 1970 or EN 60601-2-38 standards.

The bed must have a square steel frame (dimensions H 45-78 mm, W min. 20 mm, L min. 1840 mm) without protrusions. Inner distance between the head- and foot board must be at least 201 cm. The bed width is not crucial as extra wide turning sheets and slide sheets are available.

VENDLET Basic can be mounted on most beds with these dimensions. But situations where VENDLET Basic cannot be mounted can occur.



The maximum user weight and safe working load of the bed must not be exceeded following the installation of VENDLET Basic, see page 27.

Mattress requirements



The mattress must meet the requirements of the bed manufacturer and be suitable for the bed.

The maximum user weight specification of the mattress must not be exceeded.



Following the mounting of the VENDLET Basic, the distance between the mattress sides and side rails must be minimum 2.5 cm and maximum 4 cm, see page 26.



If the mattress is soft and easily compressible, it must be ensured that there is no entrapment hazard due to extra compression at the edge of the mattress.

When alternating air mattresses are used, it should be possible to inflate the mattress to a firm state before VENDLET Basic is operated. Soft mattresses will increase the friction against the mattress and create an uneven base which will be uncomfortable for the client when VENDLET Basic is operated.



If the client changes mattress, the VENDLET installation must be evaluated. A new mattress might change the conditions and necessitate the reinstallation of VENDLET Basic to reduce the risk of entrapment.

WARRANTY AND SERVICE LIFE

Vendlet ApS provides a 2-year factory warranty on VENDLET Basic. The warranty is void if the product is not used, handled and maintained in accordance with the guidelines in this manual. Opening the control unit, the bar, the corner post, or the hand control will also void the warranty.

The warranty does not include the sheets.

The VENDLET Basic service life is 10 years. The service life may be significantly extended if the product is used and handled with care and maintained in accordance with the guidelines in this manual.

The VENDLET Basic must be serviced annually by a person with relevant training, see page 35.

















IN THE EVENT OF AN INCIDENT

In case of an adverse event or a near-accident involving VENDLET Basic, the accident must be reported to the competent authority in the country in which the accident happened and to the Danish Health and Medicines Authority.



Likewise, Vendlet ApS must also be informed on phone +45 9631 0050 or vendlet@vendlet.dk.

PART 1 - General information



SYMBOLS

	The product complies with the Medical Device Regulation (EU) 2017/745
	This product is a medical device
	Legal manufacturer
	Date of manufacture
	Serial number
	Item no. / Catalogue number: 7 digits
	Consulting the manual is mandatory
	Warning triangle indicates when special attention is necessary
	For indoor use
	This product is a class II equipment (IEC 61140)
	The product is a type B equipment according to EN 60601-1
	Max. user weight
	Electronic scrap. When disposing of the products, sub-components should be recycled
IPX6 washable	This product is washable
U In:100-240VAC, 50/60Hz	The mains voltage must be 100-240 V AC.
200 W	Max power consumption is 200 W (SMPS: Switch mode power supply).
I In: max.3,9A	The current used is max 3,9 A
Int.:10% - 2/18min on/off	The system should only be used 10% of the time. After 2 min of continuous use it requires 18 min rest.
Max 200W/80 sec./ 100W/40sec @25°C	In continuous use at 25°C 200 W can be supplied for 80 sec - then the power consumption will be reduced to 100 W for 40 sec.
	This product must be stored between 0 and 50°C
	This product must be used between 5 and 40°C
	This product must be stored between 20 and 90% humidity at 30°C
	Keep dry (when stored)
Rev.	Revision no. of the label

Hand control symbols

	Power / stop button
	Tighten the sheet on the red or blue bar
	Slacken the sheet on the red or blue bar

Symbols only on sub components

	The hand control and the control unit complies with the EMC Directive 2014/30/EU and the Low Voltage Directive 2014/35/EU
	The component complies with the EMC regulation of Australia and New Zealand.
	The component complies with China RoHS.
Type + item	Product no/catalogue no
Date	Date of production
W/O	Work order









The product / system label is placed on the corner posts at the foot end.

OPERATION

The turning sheet on VENDLET Basic can only be operated with the hand control. The turning motors lock in position when not used.

The bars are raised and lowered manually. During operation, the bars must always be horizontal in the highest or lowest position.

Remember to slacken the turning sheet by pressing the  or  button before raising the bar.

Should the turning sheet be too loose on one side, you can tighten the sheet by pressing  +  simultaneously or  +  simultaneously.



Always, keep focus on the client when using VENDLET.





Remember to leave the hand control on the outside of the bed before leaving the client.

How to use VENDLET Basic

Turning

VENDLET Basic may be used to turn clients. Follow this procedure to move a client from a supine position to lying on his/her right side.

1. Turn VENDLET Basic on by double clicking the  button. Press the  button to slacken the turning sheet.
2. Raise the blue bar by lifting until it locks in both corner posts.



3. Press the  button to tighten the turning sheet on the blue bar.
4. Place the left arm of the client on his/her stomach or chest the moment before he/she starts turning.





5. Immediately after this, guide the right arm of the client to the side.



6. Then shift the left leg in parallel above the right leg.



7. The client now lies on his/her right side.
8. Press the  and  button to slacken the sheet before the client is left unattended in the bed.

The red bar does not necessarily have to be raised. But if this makes the client or the caregiver feel safer, the red bar could be raised during the process.

Watch a video on how to turn a client on our webpage www.vendlet.com or scan the QR-code.



PART 2 - User manual

Moving from one side of the bed to the other

VENDLET Basic may also be used to move clients to the side of the bed.

In many situations, this will give the caregiver a better work posture, for example in connection with examinations, training, care tasks, dressing, etc.



Moving the client to the edge also improves the contact with the client.

1. Lower the bars if they are raised: Lift the bar and press the grey button on the corner post. When it is released you can lower the foot end of the bar.







2. Do the same at the head end.



3. Turn VENDLET Basic on by double clicking the  button.
4. Press the  or  button on the hand control to move the client to the side towards you.



5. When your work is done, press the  or  button to reposition the client to the middle of the bed.
6. Press the  and  button to slacken the sheet before the client is left unattended in the bed.

PART 2 - User manual

Repositioning the client up in the bed



It is a well-known problem that clients often slide down to the foot end, for example when the back support has been raised – even if the knee break on the bed was activated before the back support.

Typically, when a client slides towards the foot end, the turning sheet follows the body of the client. In such situations, you may use VENDLET Basic to move the client up in the bed again.

Work in a zig zag pattern moving the client diagonally from side to side of the bed pulling the turning sheet on to the bar, whilst guiding the sheet to the upper end of the bar.

1. Lower the bars if they are raised.





2. Turn VENDLET Basic on by double clicking the  button.
3. Stand next to the headboard and press the  button to slacken the turning sheet on the blue bar.



4. Gently guide the turning sheet to the upper end of the blue bar while pressing the  button to pull the client to the side of the bed.



5. Stop when the client reaches the side of the bed and repeat the procedure on the opposite side.
6. Continue this process until the client has been repositioned up in the bed.
7. Press the  and  button to slacken the sheet before the client is left unattended in the bed.

Watch a video on how to reposition a client higher up in bed on our webpage www.vendlet.com or scan the QR-code.



PART 2 - User manual

Applying a sling

It is easy to apply a sling on the client when VENDLET Basic is used.

1. Turn VENDLET Basic on by double clicking the  button.
2. Use the turning function of the VENDLET system to move the client onto his/her side.
3. Place the sling along the back of the client and make sure that the sling is centred and correctly placed in accordance with the instructions of the sling manufacturer.



4. Use the VENDLET turning function to move the client onto his/her back again.



5. Free the straps on the opposite side.



6. Place all straps in such a way that they are ready to be placed on the lifting beam of the hoist.



Watch a video on how to apply a sling on our webpage www.vendlet.com or scan the QR-code.





PART 2 - User manual

Prone position

VENDLET Basic can also be used to turn a client to a prone position.

1. Place the client's right arm closely along his/her body with the palm of the hand facing the hip. Move the pillow and place it close to the right upper arm so that the client comes to lie with his/her chest on top of the pillow.



2. Turn VENDLET Basic on by double clicking the  button. Press the  button to slacken the turning sheet.
3. Raise the blue bar by lifting until it locks in both corner posts.





4. Press the  button to wind the turning sheet onto the blue bar. The VENDLET system now turns the client. Hold your hands on the client's shoulder and hip to provide a sense of safety during the procedure. Gently support the client as he/she is being turned to prone position.



5. Check that the client's head is comfortable and that there is room for breathing.











6. To return to a supine position, raise the red bar and press the  button to wind the turning sheet onto the red bar. The VENDLET now turns the client to supine position.
7. Press the  and  buttons to slacken the sheet before the client is left unattended in the bed.

Watch a video on how to prone a client on our webpage www.vendlet.com or scan the QR-code.



Side rail

If it is assessed that the client must use side rails, VENDLET Basic has integrated side rails.

1. Press the  and  buttons to slacken the turning sheet. Raise the bars by lifting until it locks in both corner posts
2. Press the  and  buttons to slacken the sheet before the client is left unattended in the bed.
3. Should the turning sheet be too loose on one side, you can tighten the sheet by pressing  +  simultaneously or  +  simultaneously.

See page 26 for further information on side rail dimensions.

Watch a video on how VENDLET Basic works as a side rail on our webpage www.vendlet.com or scan the QR-code.



Using VENDLET Basic in combination with bed functionality

VENDLET Basic does not interfere with the functionality of the bed. Slacken the turning sheet sufficiently before raising the back, thigh, and/or foot part of the bed.

Under normal circumstances, the bed surface must be level before you use VENDLET Basic.

In some situations, however, it may be advantageous to use the back or foot part of the bed when moving or turning clients. For example, if the client has wide hips and frail shoulders, he/she will rest more comfortably on the bed if the head and foot parts are raised a little before the process.

Pressure-relieving mattresses

VENDLET Basic does not reduce the effect of either pressure-relieving mattresses or alternating air mattresses. Pressure measurements have been performed which unambiguously show that VENDLET Basic does not have a negative impact on the pressure-relieving properties of the mattresses.

To prevent interference with the function of alternating air mattresses, the turning sheet must be sufficiently slackened before a client is left unattended in the bed.

At the same time, the velcro strap on the slide sheet must not be fastened too tightly on to the mattress support platform, see page 18.

We recommend that alternating air mattresses are firmly inflated before patient handling as this brings higher comfort to the client during the process.

Incontinence

VENDLET Basic can also be used for clients using incontinence sheets. The incontinence sheet should have a minimum width of 125 cm so that it can follow the client's movements during turning. You should not use two small incontinence sheets as the client in this case will lie on a double edge, which increases the risk of developing pressure ulcers.

The incontinence sheet must not be wrapped around the bars, but instead must hang loosely out over the bars.



Urine bag and drainage tube

If the client has a catheter or a drainage tube, it may be necessary to adjust the tubes, etc. individually.

Placing the urine bag or drainage tube at the foot end will often be an optimal solution. Should this not be possible, however, you could use long tubes to hang the urine bag or drainage bag on the outer surface of VENDLET Basic.

In such cases, the bag should be placed on the lowest support bar on the side rail by the foot board. Route the tube out between the corner post and the side rail support bars. Be careful to avoid squeezing the tube.

ATTACHING THE SHEETS

Place a slide sheet directly on top of the mattress, followed by the turning sheet which is then attached to the two bars.

Slide sheets and turning sheets are available for standard bed sizes and optionally with increased width which makes VEND-LET Basic suitable for wider beds as well.

Slide sheet width	Fits mattress widths	Fits mattress length
95 cm (regular size)	80 - 90 cm	205 cm
95 cm - long	80 - 90 cm	220 cm
115 cm	95 - 110 cm	205 cm
115 cm - long	95 - 110 cm	220 cm
135 cm	110 - 130 cm	205 cm

Turning sheet width	Fits mattress widths
270 cm (regular size)	80 - 100 cm
320 cm	100 - 130 cm

Slide sheet

1. Fold the slide sheet corner elastic straps around the mattress. Check that the surface is smooth and even without creases and folds. Make sure that the slippery side is facing upwards.



2. Fasten the velcro straps around the edge of the mattress support platform. It is important that the straps are fastened around the edge of the platform under the mattress and not around the bed frame as this will prevent the back, thigh, and foot parts of the bed from being raised.



The straps are long enough for thick mattresses.

The slide sheet is subject to extensive wear and must be checked regularly. The friction of the turning sheet against the mattress will increase if the bed is not fitted with a slide sheet or the slide sheet has been damaged. That will reduce the comfort of the client during moving and handling.

When an alternating air mattress is fitted with a slide sheet, it is important that the velcro straps are not fastened too tightly around the edge of the mattress support platform as this could interfere the function of the alternating air mattress. Consequently, the mattress should be fully inflated while fitting the slide sheet.

Turning sheet





Attaching the turning sheet before use



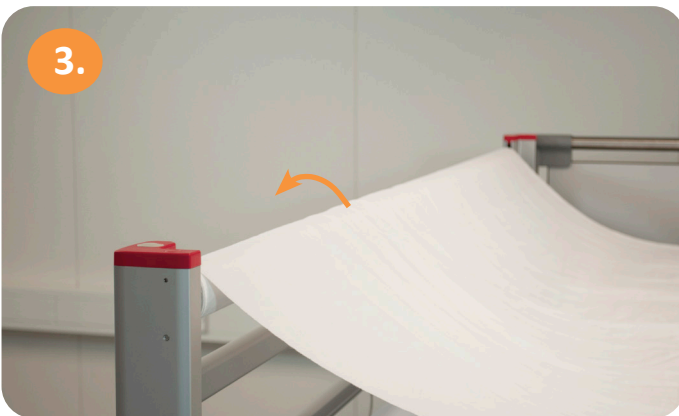

1. Place the turning sheet in the middle of the bed
2. Press the edge strip of the turning sheet into the groove on one of the bars; begin at the head end of the bed and work your way down to the foot end.



3. The turning sheet must always be placed OVER the bars to prevent fingers, hair etc. of the client from getting caught under the sheet. If the sheet is placed under the bars, the pulling power will be reduced, and the motors will switch off when the turning sheet is pulled in by the bar.



4. Press the  or  button on the hand control and allow approx. two-thirds of the sheet to be pulled in by the bar.
5. Press the edge strip at the opposite edge of the turning sheet into the groove on the other bar.
6. Use this bar to pull in the turning sheet by pressing the  or  button until the sheet covers the mattress evenly with the red line at the centre of the mattress.

7. The bars on the VENDLET Basic turn together. If the red bar pulls, the blue bar starts slackening, and vice versa. If you don't want the sheet to be slackened at the opposite bar, press both  +  simultaneously or  +  simultaneously.

What should I do if the turning sheet is rolled askew on the bars?

Occasionally, the turning sheet will roll askew on the bars. As such, this is insignificant and VENDLET Basic will still be operable.

This could result in creases in the turning sheet under the client which is undesirable. Hence, we recommend that you aim to smooth the turning sheet if the sheet is askew by more than a hand's width on the bars.

In this situation, you will have to slacken the sheet that has been pulled askew and pull it in again while guiding / smoothing it with your hand.

Watch a video on how to attach the sheets on our webpage www.vendlet.com or scan the QR-code.





PART 2 - User manual

Changing the turning sheet on an occupied bed

1. Position the client on his/her side and then move him/her to the centre of the bed.
2. Remove the old turning sheet from the bar facing the back of the client and fold the sheet in layers or roll it. Tuck it underneath the client.



3. Attach the new turning sheet to the bar and press  or  button to roll the new turning sheet onto the bar.



4. Allow approx. half of the new turning sheet to roll onto the bar and stop when the red line on the sheet is at the centre of the mattress. Fold the remaining part of the new turning sheet in layers or roll it. Tuck it under the turning sheet being replaced.



5. Use the opposite bar to move the client to a supine position on top of the new and the old turning sheets.



6. Remove the old turning sheet and attach the replacement sheet to the bar.



Watch a video on how to change the sheet on an occupied bed on our webpage www.vendlet.com or scan the QR-code.



EVACUATION

Evacuation of clients should happen via the end of the bed, or via the side of the bed.

Evacuation via the foot end of the bed

1. Remove the footboard.
2. Cut the turning sheet between the mattress and the bar.
3. Evacuate the client via the end of the bed.

Evacuation via the side of the bed

In case you have power:

1. Lower the bar on the evacuation side.
2. Use the VENDLET to pull the client to the side of the bed and evacuate.

In case you do not have power:

1. Lower the bar on the evacuation side.
2. Cut the turning sheet between mattress and the bar.
Pull the client to the side of the bed and evacuate.

DAILY MAINTENANCE

VENDLET Basic is a reusable medical device intended for long-term use, requiring safe procedures in connection with cleaning and maintenance.

Daily inspections

VENDLET Basic must be checked daily in accordance with the checklist below. If a "Yes" checkbox is marked, this indicates a desired result. If a "No" checkbox is marked, this indicates a risk in which case the VENDLET system must not be used.

In case of malfunctions, faults, missing parts, or improper fitting, contact a person with relevant training for inspection or repair.

	Checklist for daily inspections	In case of No, do not use VENDLET Basic
1	Is VENDLET Basic free from visible damage and crooked brackets and fittings?	<input type="checkbox"/> Yes <input type="checkbox"/> No
2	Do the bars lock in both corner posts, when the bars are lifted?	<input type="checkbox"/> Yes <input type="checkbox"/> No
3	Are the nylon straps attached to the bed frame and all the support bars?	<input type="checkbox"/> Yes <input type="checkbox"/> No
4	Is the the turning sheet in good condition and does the sheet run over the bars?	<input type="checkbox"/> Yes <input type="checkbox"/> No
5	Is the slide sheet fastened around the edge of the mattress support platform and in good condition? Is the slippery side facing upwards?	<input type="checkbox"/> Yes <input type="checkbox"/> No
6	Double-click the  on the hand control. Does the green diode on the hand control illuminate? Does everything work when you press the matching hand control buttons?	<input type="checkbox"/> Yes <input type="checkbox"/> No
7	Has it been verified that the condition of the client and the mattress/bed/client combination have not changed relative to when VENDLET Basic was mounted?	<input type="checkbox"/> Yes <input type="checkbox"/> No
8	Are the caregivers familiar with the instructions of this manual and have they received training in the use of VENDLET Basic?	<input type="checkbox"/> Yes <input type="checkbox"/> No
9	Is the quick guide located at an easily accessible spot near the bed?	<input type="checkbox"/> Yes <input type="checkbox"/> No
10	Has it been verified that the date of the next annual inspection has not been exceeded?	<input type="checkbox"/> Yes <input type="checkbox"/> No

PART 2 - User manual

Cleaning and washing instructions

Cleaning of electrical and mechanical parts

The VENDLET Basic is machine washable by automatic washing systems according to IEC 60529 (IPX6 washable).

If cleaned manually:

Clean the electrical and mechanical parts with a damp cloth with water or a mild soap solution and then wipe the parts with a dry cloth. You may also use water under pressure, but the system must not be hosed down directly with a high-pressure cleaner.

Disinfection:

You could also use a dry cloth with disinfectant. All common disinfectants for normal use present in care homes and hospitals may be used.

If using washing machine:

Only flat squirt nozzles are allowed. An approved setup could be:

- Water Pressure 3 bar, water volume 5,61 L/min, dispersion angle 120° flat squirt nozzle.
- 2 min washing with 70° C water at a pH-value 5-8, with cleaning agent.
- 20 s rinse with 85° C at a pH-value 5-8 and 0,2% rinsing solution
- 10 min cooling at 20° C ambient temperature

When washed by automatic washing machine, VENDLET Basic must dry for 24hr before use.

Mounting during washing:

Raise both side rails and turn the motor bars so that groove for attaching the turning sheet is facing downwards.

The components should be mounted with the plug inserts facing downwards or situated so that they are protected from direct impact from the water nozzles. The lid covering the cable inserts on the control unit must be closed during the entire cleaning procedure.

Equally, all cables must be plugged in and guided in such a manner, that there is no apparent strain to the interface between the cable and its connection (for instance between cable and control unit). It is furthermore recommended that the control unit is situated as far away from the water nozzles as possible.

Industrial high-pressure cleaning is NOT allowed.

Water:

Degree of hardness must not be more than 5° dH and no demineralized water can be used.

Recommended cleaning agents:

- Sekumatic FDR or FRE from Ecolab
- Neodisher Dekonta from Dr. Weigert
- Thermosept NDR from Schulke or similar with a pH-value of 5-8 and in a concentration of 0.5%.

Recommended rinsing solution:

- Sekumatic FKN from Ecolab
- Neodisher BP or TN from Dr. Weigert
- Thermosept BSK from Schulke or similar with a pH-value of 5-8 and in a concentration of 0.2%.

The rinsing agents must not contain caustic solutions. They must not change the surface structure or adhesive properties of the plastic and must not break down grease.



The system must not be hosed down with high pressure cleaner



Interconnecting cables must remain plugged in during cleaning to prevent the ingress of water



Cleaning with steam cleaner is not permitted

Washing instructions, slide sheet



Recommended washing temperature: 60°C
Do not add fabric conditioner.



Do not tumble-dry



Do not iron

Washing instructions, turning sheet



Recommended washing temperature: 90°C
Max. 4% shrinking







Tumble-dry at normal temperatures



Iron or mangle at high temperatures

Troubleshooting - daily use

Problem	Checklist
Is there an acoustic alarm when a button on the hand control is activated?	Reset the system by simultaneously pressing the  and  buttons on the hand control. You will hear 10 rhythmic beeps. Press and hold the buttons until the beeping stops.
VENDLET Basic does not work	Is the control unit connected to 230V outlet and is the power on? Is the green diode on the control unit illuminated?
	Are all plugs properly connected on the control unit?
	Is the green diode on the hand control illuminated? Double-click the  button to activate the system.
One of the bars does not work	Are all plugs properly connected on the control unit?
	Is the cable to the bar intact?
One or both bars do(es) not turn when the client is lying in bed	Is the turning sheet running under the bars? The sheet must be over the bars.
	Are all plugs properly connected on the control unit?
The hand control buttons are not working	Are all plugs properly connected on the control unit?
	Double-click the  button to activate the system.
	Is the correct hand control used? The VENDLET Basic only works with the VENDLET Basic hand control (see page 8).
One of the bars will only turn in one direction	Are all plugs properly connected on the control unit?
	Is the cable to the bar intact?

Contact a person with relevant training, your distributor or Vendlet if the above does not solve the problem.

PART 3 - Technical manual

UNPACKING

VENDLET Basic is delivered in 2 boxes with a weight of approx. 17 kg each.

VENDLET Basic is partially assembled on delivery, ready for mounting on the bed. Check the packaging and contents for signs of damage and contact the distributor in case of obvious damage.

Parts list

1	unit	Blue side complete
1	unit	Red side complete
1	unit	Suspension bracket for control unit
1	unit	Control unit
1	unit	Power cable - 230 V
1	unit	Hand control
1	bag	16 mounting bolts
8	unit	Mounting plates
1	unit	Slide sheet
1	unit	Turning sheet
1	unit	Quick guide
1	unit	Manual

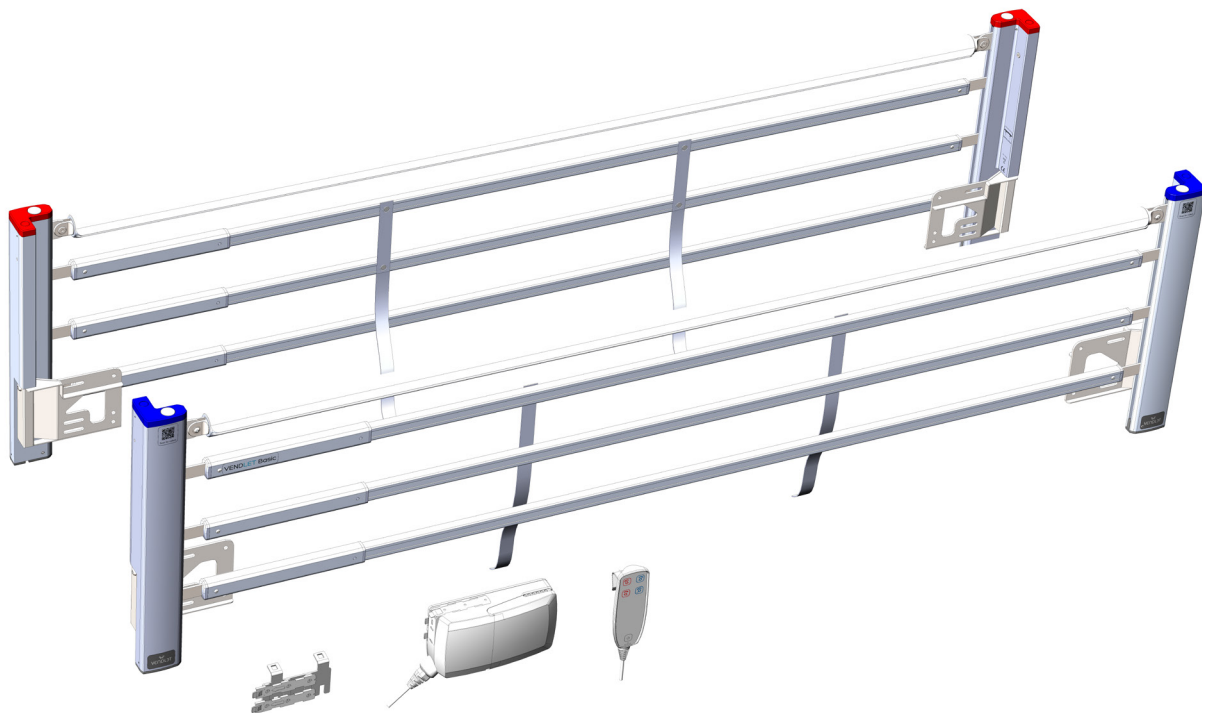

PART 3 - Technical manual

MOUNTING

VENDLET Basic should always be installed by a person with relevant training.



Inkompatibler madrasser kan forårsake risiko for klemfare.

Preparations

Tools and bolts

Allen key 6 mm

Nipper

Button head bolts: 16 x M8 x 40 mm

Dimensional requirements, side rails

If the bed is equipped with side rails, these must be removed before mounting VENDLET Basic. VENDLET Basic has been tested and approved to function as side rails in accordance with the requirements of EN 60601-2-52:2010.

When mounting VENDLET Basic you should take the following dimensions into account:

A:

A distance of 2.5 – 4 cm (A) is required between the mattress and the side rail on both sides of the mattress. Likewise, it is important that the mattress guides are suitable for the mattress and will hold the mattress in place.

If necessary, use one or two 15 mm spacers, to pull the mounting bracket away from the bed frame.

B:

In order to meet the side rail requirements, the upper edge of the bars must be mounted at least 22 cm (B) above the mattress surface.

C:

The lower part of the side rail must always be at least 12 cm (C) above the ground.

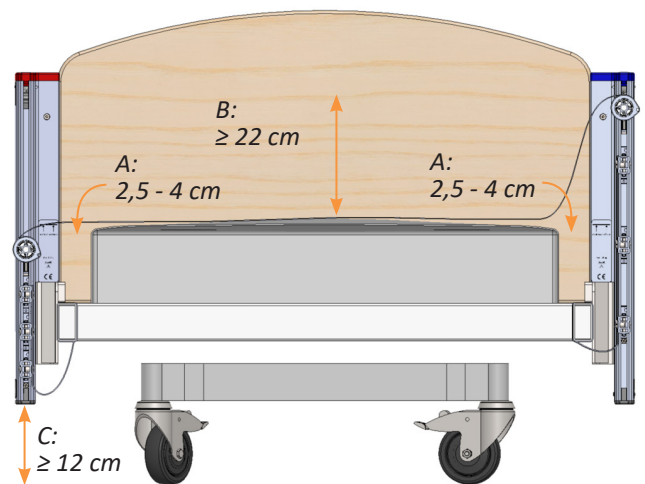

D:

The length must be adjusted in order to ensure that the gap between the board and VENDLET Basic is less than 0,8 cm or more than 2,5 cm (D). However, the gap must not exceed 6 cm.

VENDLET Basic is telescopic in length and can be extended from 200 cm to 220 cm.

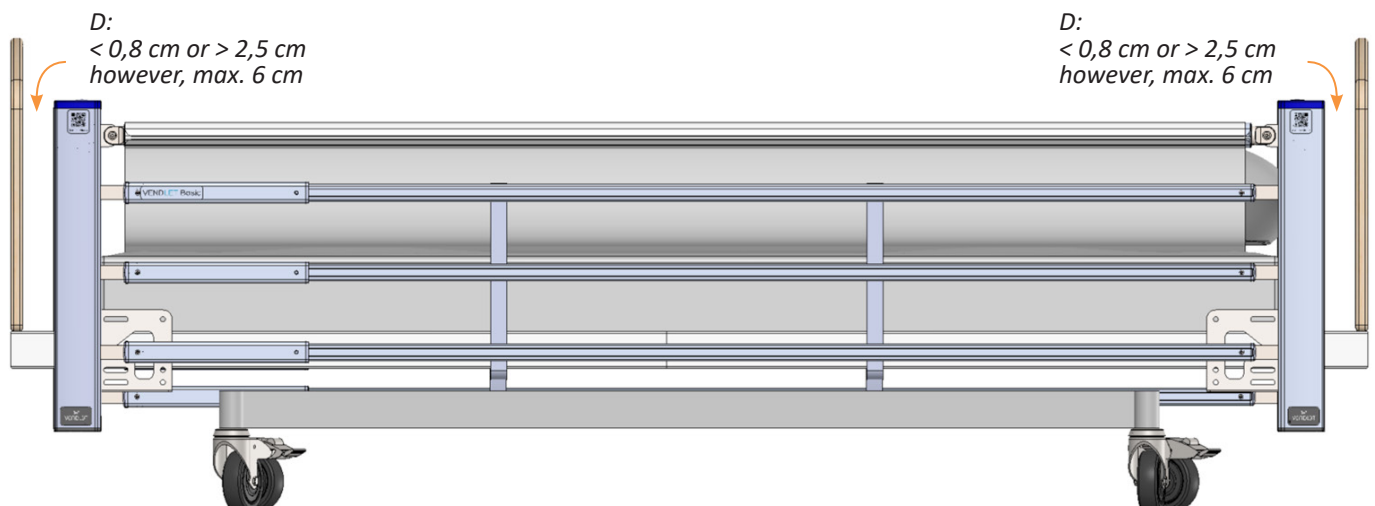

PART 3 - Technical manual

Maximum loads



The max. user weight for VENDLET Basic is 150 kg.



Since VENDLET Basic is always mounted on beds, it is important to consider the whole solution. You should always check the safe working load (SWL) of the bed and ensure that the combined weight of the client, the VENDLET system and any other equipment on the bed never exceeds this limit.

In home care situations the weight of other equipment is estimated to be 25 kg. In this case the SWL of the bed must be at least 205 kg to be able to handle a user weight of 150 kg:

Max. user weight		VENDLET Basic		Other equipment		Required Bed SWL
150 kg	+	30 kg	+	25 kg	=	205 kg

In intensive care situations the weight of other equipment is estimated to be 55 kg. In this case the SWL of the bed must be at least 235 kg to be able to handle a user weight of 150 kg:

Max. user weight		VENDLET Basic		Other equipment		Required Bed SWL
150 kg	+	30kg	+	55 kg	=	235 kg

Mounting

Grab the motor bar when lifting VENDLET Basic - not the support bars.

Attaching a side

The sides are determined by the supine position of the client. The red bar must be placed on the right side and the blue bar on the left side of the client.

The bars must be in upper position during mounting.

1. Attach the mounting plates at the top with a button head bolt. Do that in both ends.

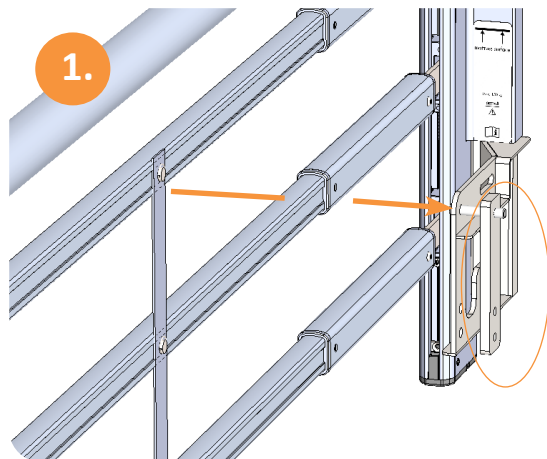

2. Place the side on the steel frame of the bed.

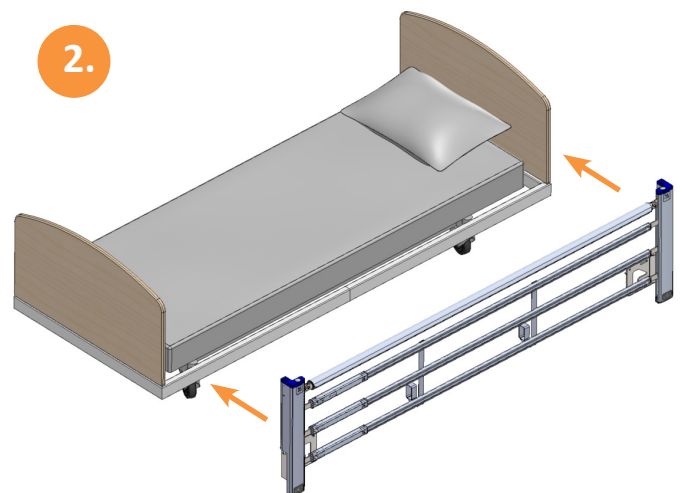

Scan the QR-code and watch a video on how to mount VENDLET Basic.



PART 3 - Technical manual

3. Place the corner post as close to the headboard as possible. Fit the button head bolt in the bottom of the bracket.

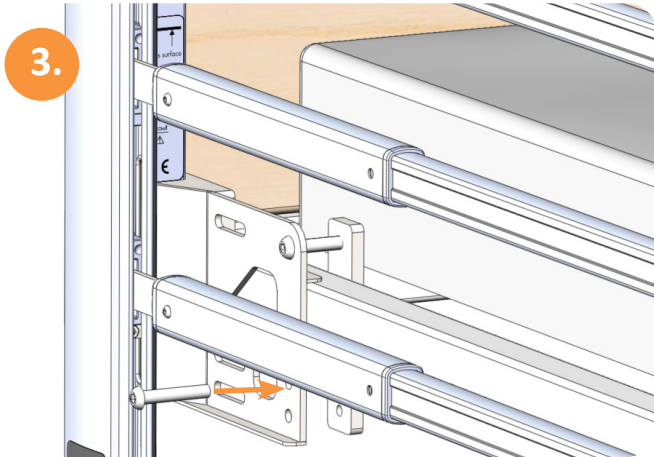

6. Attach the outer mounting bracket in both ends and tighten the button head bolts evenly.

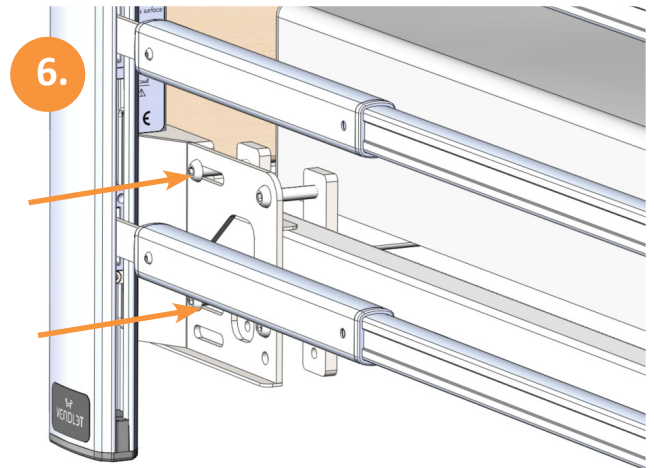

4. Tighten the button head bolts evenly at the head end.

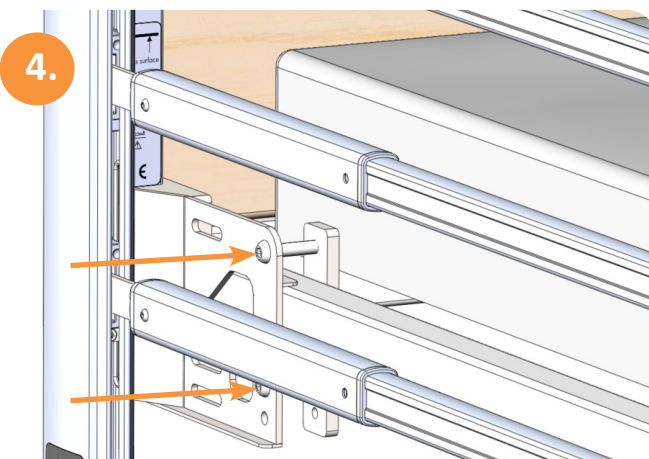

7. Ensure that the distances meet the dimensional requirements described on page 26.

5. Adjust the length of the side and place the corner post as close to the footboard as possible. Fit the button head bolt in the bottom of the bracket. Tighten the button head bolt evenly. Tighten the bracket at the foot end.

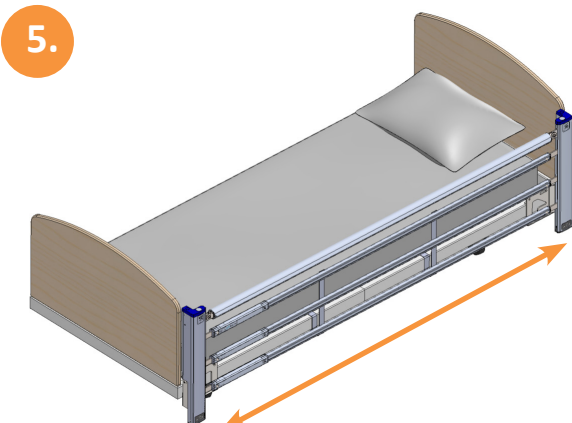

PART 3 - Technical manual

Height adjustment

Always adjust the height of VENDLET Basic in accordance with the instructions on page 26 and the height of the mattress.

The height can be adjusted up to 7,7 cm. The height adjustment has 7 possible positions.

1. Make sure, that the surface of the bed is flat and horizontal.
2. If the mattress is an alternating airmattress, make sure it's fully inflated.
3. Place the bar in the highest position.
4. Press the small button on the corner post.

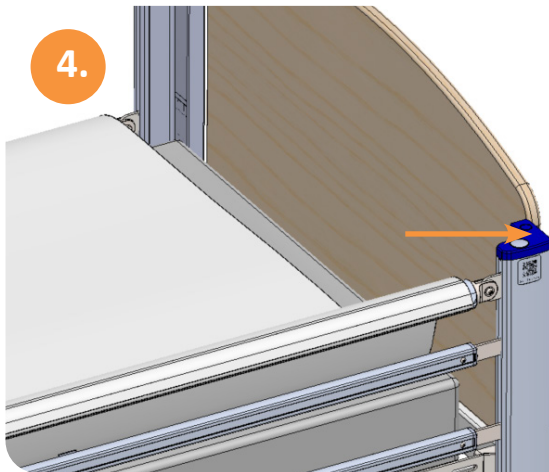

5. Simultaneously, lift the corner post until the surface of the mattress is in level with the mark inside the corner post.

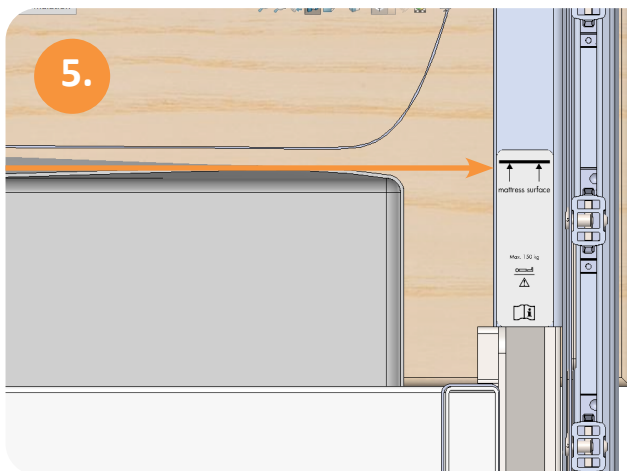

6. Repeat the procedure at the other three corner posts. Make sure all 4 corner posts are left in the same height.
7. When the system is raised to the highest position, it can be lowered again.

8. Tighten the side rail straps around the steel frame.

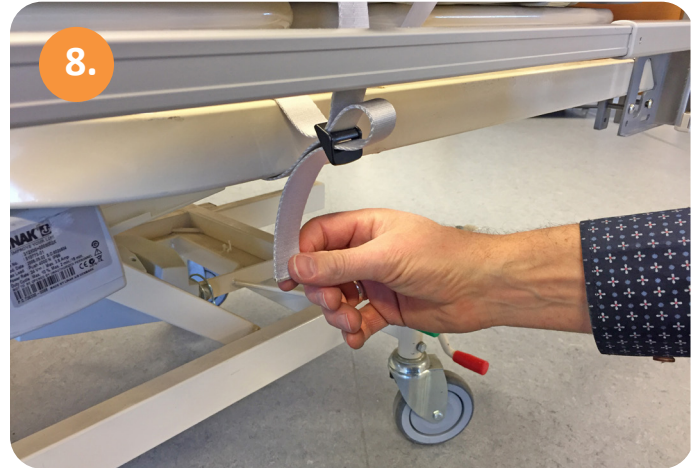

9. The blue side mounted and height adjusted:

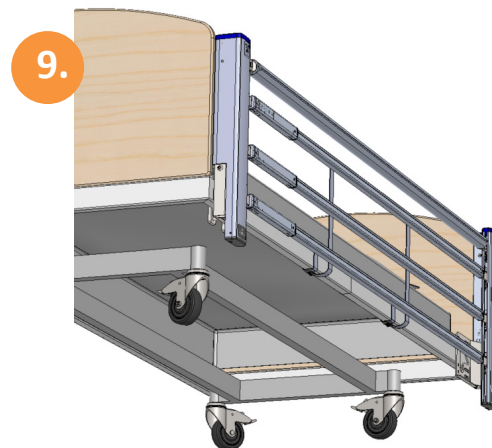

PART 3 - Technical manual

Electrical parts

Mounting the control unit

The control unit is mounted under the bed, usually on the bed frame against the headboard but could also be placed in other locations with free space.

1. Place the suspension bracket in an appropriate location on the base of the bed. Use cable ties.

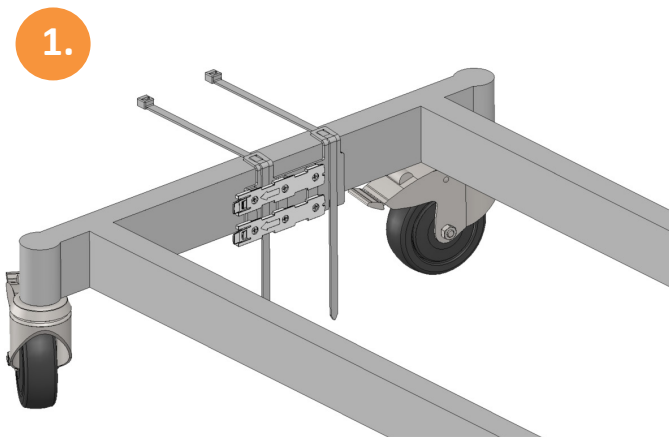

2. The suspension bracket is now placed correctly.

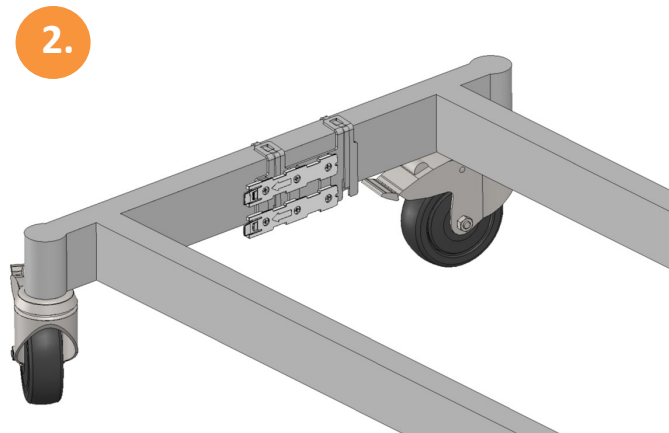

3. Attach the power cord to the control unit.
4. Slide the control unit onto the suspension bracket till it clicks on.

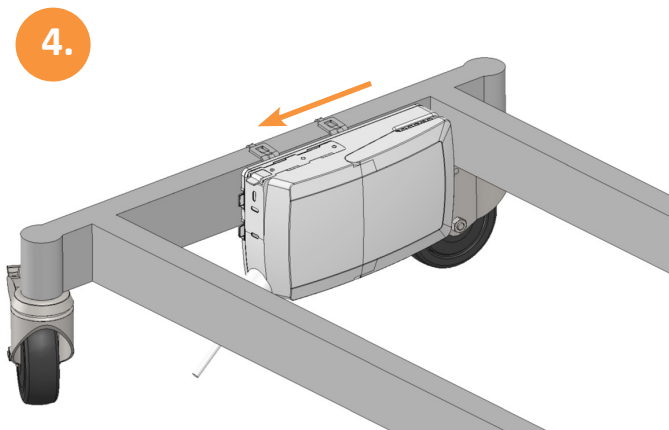

PART 3 - Technical manual

Connecting the control unit

The hand control should be connected before the power cable is connected to a main plug.

1. Connect the hand control to the control unit in the socket shown below.



2. The plug on the red bar motor cable is fitted with a red O ring. Connect the cable from the red bar to the control unit in the socket shown below (marked with a red color code).



3. The plug on the blue bar motor cable is fitted with a blue O ring. Connect the cable from the blue bar to the control unit in the socket shown below (marked with a blue color code).

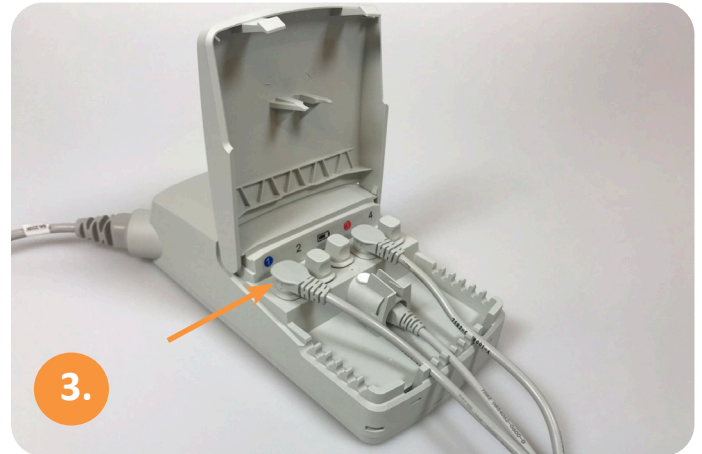

4. Close the control unit.



PART 3 - Technical manual

Connecting the power cables

The last step is to connect the control unit power cable to an easily accessible 230V mains plug. The green diode on the control unit illuminates when the power is turned on.

Keep all cables away from the floor and the moving parts of the bed. Loose / excessive cable can be attached to the bedframe with cable ties next to the control unit.



Incorrect handling of cables can cause electric shock or product failure.

- Do not bend, break or cut the power cord or otherwise damage it.
- Do not run over the power cord with the bed.
- Do not insert the power cord into moving parts.
- Unplug the power supply cord before moving the bed.
- Ensure that no cables (power cord or cables from other equipment) are jammed or otherwise damaged when the bed is in use.
- Keep bed components and accessories at least 30 cm away from heated surfaces and direct sunlight.
- Do not position the VENDLET Basic in a way that it is difficult to disconnect the mains plug. The mains plug in the wall is used as an appliance coupler.

Attaching the sheets

Please refer to page 18-19 for instructions on how to attach the sheets.

QUICK GUIDE LOCATION

The quick guide should always be placed where it will be visible from the bed and in close proximity to the bed.

PART 3 - Technical manual

FINAL INSPECTION CHECKLIST

Always perform a final inspection after completing the installation. The final inspection is carried out by following the checklist below. The list may also be downloaded at www.vendlet.com.

If there are ticks in the column “No”, it must be assessed whether VENDLET should be used until the matter is resolved.

Final inspection checklist	Yes	No
Is VENDLET Basic mounted by a person with relevant training?		
Is the combined weight of the client, VENDLET Basic and any other equipment on/in the bed below or equal to the max. safe working load of the bed?		
Have the side rail dimensioning requirements been met (length and height)? (page 26)		
Can both side rails be raised and lowered easily?		
Are all corner posts adjusted to the same height according to the mattress? (Page 26)		
Can both side rails be locked in highest position?		
Can both side rails be loosened from highest position?		
Are the nylon straps attached to the bed frame and all the support bars?		
Are the nylon straps intact?		
Are the plastic parts intact and without signs of wear?		
Are all wires intact?		
Do both bars slacken and tighten the sheet?		
Does the timer activate when the button is pushed twice within 2 seconds?		
Does the timer turn off after 90 seconds of idle time?		
Is the control unit securely suspended?		
Are all cables securely attached to the control unit?		
Have the lid on the control units been closed properly and is the lid intact?		
Are all loose cables off the floor?		
Is the slide sheet fitted on top of the mattress and properly attached?		
Does the turning sheet runs over the bars?		
Is the quick guide visible and located near the bed?		
Is the VENDLET Basic manual available?		
Have the caregivers been instructed on the use of VENDLET Basic and its functions?		
Has VENDLET Basic system been signed up for an annual service check?		

Date: _____

Carried out by: _____

Serial no.: _____

Bed model: _____

Mattress model and dimensions: _____

Client: _____

Address: _____

Date of next service check: _____

DISMOUNTING, STORAGE AND REMOUNTING

Dismounting

VENDLET Basic may be dismantled and transferred to another bed.

1. Remove the turning sheet and slide sheet.
2. Raise the VENDLET Basic bars to highest position.
3. Disconnect the power cable from the outlet.
4. Disconnect the cables from the control unit.
5. Dismount the control unit by cutting cable ties.
6. Now VENDLET Basic can be dismantled. Loosen the bolts in the mounting plates and turn them aside to lift VENDLET Basic off the bed frame. Optionally, use the mounting trolley to transport VENDLET Basic to a new destination.

Storage

Store VENDLET Basic in the original packaging until mounting.



Indoor



0° C (32° F) Min
+50° C (122° F) Max



20–90% at 30°C



Keep dry

Remounting

Follow the procedure described in the section “Mounting” if remounting is required.





Before remounting, you should check all parts of VENDLET Basic for damage and that the date of the annual service check has not been exceeded, and that VENDLET Basic has been properly cleaned / disinfected.

MAINTENANCE/CHECK

Annual check

VENDLET Basic must be serviced by a person with relevant training annually. This check will ensure that the safety issues pertaining to VENDLET Basic are in compliance with the standard as well as a long service life. The annual check includes the following:

Electrical parts

Control unit no.:		
Check the control unit including cables, plugs and mounting fittings for signs of damage.		
Check whether the timer deactivates after 90 seconds of idle time.		
Check whether the green diode is illuminated.		
When using an extension cable, check whether the cable has the necessary quadrant (1.0 mm ²).		
Battery no. (if fitted):		
Check the battery for signs of damage or corrosion.		
Check that the battery backup works.		
Hand control no.:		
Check the hand control, cables and mounting fixtures for signs of damage.		
Check the functioning of all buttons and whether the green diode is illuminated when the system is active.		
Check all plugs, cables, and relief cables.		
Check the stop function.		
Bars	Red side	Blue side
Check the motors for signs of damage.		
Check all cables, plugs, and relief cables for signs of damage.		
Check whether the bar can be operated manually when the motor is disconnected from the control unit.		
Check whether the motor has full pulling power when you press the  /  and reduced pulling power when you press the  /  by stopping the bar with your hand.		

Mechanical parts

Check for signs of damage, damaged plastic parts and crooked fittings or brackets and missing parts.
Check the bars and support bars for dents/deformations.
Check whether the groove on the bar is in good shape and works with the edge strip of the turning sheet.
Check that the nylon straps are intact, fitted correctly to the bed and side rails.
Check that the motors run correct, without any strange noises.
Check if the wear rings in the bars need to be exchanged.

Sheets

Is the turning sheet in good condition?
Is the slide sheet in good condition?

Functional tests

Do all bolts match the parts list and are they evenly tightened?
Does the mounting meet all side rail dimension requirements?
Check whether it is possible to raise and lower the bars freely.
Check whether the VENDLET Basic works as intended when the hand control is activated.

Replacements of parts

Installation instructions for replacement of bar incl motor, support bars, plastic sliders for support bars, control unit, hand control, nylon straps and corner post can be provided on request.

After any repairs or replacements all points of the “Checklist for daily inspections” (page 22) must be controlled.

TROUBLESHOOTING - TECHNICIANS

Problem	Checklist	Repairs
VENDLET Basic does not work.	Is the green diode on the control unit under the bed illuminated?	If not, check that the power is turned on and functional. Check that the power cable is connected to the control unit.
	Is the green diode on the hand control illuminated?	If not, make sure all cables are properly mounted and intact. Replace the hand control.
	Is there an acoustic alarm when a button on the hand control is activated?	Reset the system by simultaneously pressing the two top buttons on the hand control. You will hear 10 rhythmic beeps. Press and hold the buttons until the beeping stops.
	None of the above?	Contact a person with relevant training.
The bar starts but stops pulling immediately afterwards.	Does the client weigh more than max. user weight?	If max user weight is exceeded acquire a VENDLET with higher user weight.
	Is part of the mattress or blanket rolled onto the bar with the sheet?	Make sure only the turning sheet is rolled on to the bar.
	Is the turning sheet attached correctly?	Make sure the turning sheet is placed OVER the bar.
One of the bars does not work.	Is the cable to the bar damaged?	If damaged, replace the cable for the bar.
	Is the cable intact?	Switch the plugs of the two bars. If the same bar still does not work, then the motor of that bar is defect. If the other bar is not working, then the hand control or the control unit is defective. Replace the hand control. If this does not solve the problem, replace the control unit.
	Is the motor malfunctioning?	Replace the bar.
	None of the above?	Contact a person with relevant training.
One or both bars does not work when a load is applied.	Does the turning sheet run over the bar, cf. page 19 of the user manual?	If the sheet runs under the bar, the motor disconnects when loaded. This is a safety feature.
	Switch the plugs of the two bars.	If the same bar still does not work, then the motor of that bar is defective. If the other bar is not working, then the hand control or the control unit is defective. Replace the hand control. If this does not solve the problem, replace the control unit.
	None of the above?	Contact a person with relevant training.
The hand control buttons are not working.	Is the plug properly connected to the control unit?	Mount the plugs correctly in the control unit.
	Is the cable damaged?	If yes - replace the hand control.
	None of the above?	Contact a person with relevant training.
One of the bars only turn in one direction.	Are all plugs properly connected on the control unit?	Mount the plugs correctly in the control unit.
	Is the cable to the bars damaged?	If yes - replace the cable for the bar.
The bar stays up when elevated.	Is the grey button missing?	If yes – install a new button
	Is the grey button down?	If yes – replace the top lid on the corner post
	None of the above	Replace the top lid on the corner post

PART 3 - Technical manual

TECHNICAL DATA

In accordance with the Medical Device Regulation (EU) 2017/745, VENDLET Basic is a class I product.

	VENDLET Basic
Product no.	6200000
Max. user weight	150 kg
Control unit:	
Power supply	SMPS 200W
Mains supply	100-240 Volt AC, 50/60 Hz
Power rating	Max 200 W
Protection	Class 1
IP class	IPX6 Washable
Intermittence	10%, max 2 min / 18 min.
Output voltage	24 Volt DC
Weight:	
Total system	approx. 30 kg
Red side	approx. 14,5 kg
Blue side	approx. 14,5 kg
Control unit	approx. 0,7 kg
Battery (accessory)	approx. 0,7 kg
Length:	200 - 220 cm (telescopic)
Width:	May be adapted to beds between 70 and 130 cm
Expected service life	10 years
Noise level at max. load	65 db(A)
Turning sheet:	
Regular width and length	270 cm / 183 cm
Material	100 % cotton
Slide sheet:	
Regular width and length	95 cm / 210 cm
Material	100% nylon
System service check	Annually

Battery (optional):	Li-Ion 2,25 Ah / 24 Volt DC
Duty Cycle:	5 %, 1 minute continuous use followed by 19 minutes not in use
Charging:	With integrated charger in battery
Charging time:	Approx. 10 hours
Operating temperature:	+ 5 °C to + 30 °C
Storage temperature:	- 10 °C to + 40 °C (+ 10 °C to + 25 °C recommended) The batteries must be stored in an applicable storage room without direct sunlight
Relative humidity:	20 % RH to 80 % RH, non-condensing
Atmospheric pressure:	700 to 1060 hPa
IP class	IPX6 washable

Battery backup

Recharging during storage

First recharge of the battery must be no later than 12 months after production date stated on the label. Hereafter the battery must be recharged at least every 12 months.

DO NOT

- Heat or burn the battery
- Short circuit the battery
- Expose the battery to high impact
- Crush or puncture the battery
- Use batteries with signs of damage or corrosion
- Change or store the battery near combustible material
- Expose the battery to water or other liquids when unplugged

LED functionality

LED	Indication of operating
Solid yellow	Charging
No LED Light	Fully charged
Flashing yellow	Error during charging

Buzzer functionality

The buzzer will make a warning when a button on the hand control is pressed and the battery capacity is low.

Power consumption

	VENDLET Basic	
Standby		2,5 Watt
	Tighten sheet (without person)	50 Watt
	Slacken sheet	20 Watt
	Moving a person at 90 kg	115 Watt
	Moving a person at 150 kg	158 Watt

ESSENTIAL PERFORMANCE

This equipment is compliant with IEC 60601-1-2, meaning that no loss of essential performance is found due to electromagnetic disturbances. The essential performance of VENDLET Basic refers to control of the bars using the hand control (see page 8-9 - How VENDLET Basic works).

The electrical circuit is equipped with a double fault safety which requires both a power request and a keystroke on the hand control to operate.

In the unexpected case of corruption of the electrical system due to electromagnetic disturbances, the expected outcome is a non-functioning control unit without any motor function.



Use of this equipment adjacent to or stacked with other equipment should be avoided because it could result in improper operation. If such use is necessary, this equipment and the other equipment should be observed to verify that they are operating normally.



Portable RF communications equipment (including peripherals such as antenna cables and external antennas) should be used no closer than 30 cm (12 inches) to any part of the VENDLET Basic, including cables specified by Vendlet ApS. Otherwise, degradation of the performance of this equipment could result.

ENVIRONMENTAL CONDITIONS AND DISPOSAL

Environmental conditions

Operation:	
Temperature	5 – 40°C
Air humidity	20 – 90% at 30°C – no condensation
Atmospheric pressure	700 – 1060 hPa
Storage:	
Temperature	0 – 50°C
Air humidity	20 – 90% at 30°C – no condensation
Atmospheric pressure	700 – 1060 hPa
Transport:	
Take the necessary precautions to protect the electric components against rough jolts, shocks etc.	
After transportation at low temperatures the motors in the bars might work irregularly until they have been warmed up to normal room temperature.	

Disposal

Do not discard VENDLET Basic with general household waste. On disposal of VENDLET Basic, Vendlet ApS recommends that the system be divided into individual parts and components for recycling.

The control unit must be disposed of as electronic waste. Furthermore, it may be divided into metal waste, cable waste, electronic waste, and reusable plastic.

The hand control may be disposed of as electronic waste. Furthermore, it may be divided into cable waste, electronic waste, and reusable plastic.

Turning sheets and slide sheets can be washed and handed in for recycling. However, very dirty sheets must be disposed of as combustible waste.

Manufacturer:

Vendlet ApS
Egelund 33
6200 Aabenraa
Tel.: 96 31 00 50
vendlet@vendlet.dk
www.vendlet.com



All rights reserved.
Copyright Vendlet ApS